



McGEE COMPANY

SINCE 1951

Albuquerque • Atlanta
Dallas • Denver • Salt Lake

1-800-525-8888

www.McGeeCompany.com

Automotive Service Equipment
Tire Service Supplies
Retreading Equipment & Supplies
Passenger/Truck/OTR

EXPIRES 4/1/26

All prices are F.O.B. our warehouse unless otherwise specified.
Lease figures are approximate and subject to change.



PRICES SUBJECT TO RAPID CHANGE
DUE TO IMPACT OF TARIFFS
VISA AND MASTERCARD ACCEPTED
3% Service fee on all credit cards



Premium Quality Chemical Vulcanizing Rubber Patches

Stems Repair Unit



JSU - Combi

Note: The JET Combi may only be used when the angle of the injury is LESS THAN 25°. If the injury angle is GREATER THAN 25°, repair with the appropriate two-piece stem and repair unit.



Repair Unit	Inch	mm	Cutter	Qty/Box	Price
SCU03	1/8	3	BU18T	24	\$27.08
SCU06	1/4	6	BU14T	24	\$33.96
SCU08	5/16	8	BU516N	24	\$40.58
SCU10	3/8	10	BU38T	10	\$34.25

5-Gallon Bead Seater

- 5-gallon capacity
- Equipped with a butterfly valve for maximum air discharge
- Designed for commercial use on large truck tires, passenger and ATV tires to 24.5"
- Made in Taiwan



\$179.99

473-01500
5-Gallon
Bead Seater

Largest stock of tire chains in the Rocky Mountain Area!

See page 36



Wide Base Truck
Cam Chains



Autosock



DUO Tractor Chains

IR285B6 Promo* \$499.99

- 6-Vane Motor
- Dual Handle
- 6 Inch Anvil (285B-6 only)
- Rocking Dog Impact Mechanism
- Feather-Touch Trigger with 1,475 ft-lbs of torque



McGee exclusive while supplies last

Buy an IR285B6 and get a FREE 5-piece socket set (\$125 value)



Commercial TPMS is here!

- McGee Company has options from Autel, Dill, Schrader and Walker!
- Metal or Fabric band options available with Autel ITS600CV and CVSA01 433Mhz sensors
- Want stems for existing systems? See page 25.



Full Autel
CV setup



75 & 75N(low profile) Mounting Compound now in pink! \$18.99/ea

- Every case of the paste donates 30% of our profit to the Susan G. Komen foundation fighting breast cancer.
- Track McGee Customer Impact: <https://www.mcgeecompany.com/breastcancer/>
- Designed for alloy wheels, low profile and run flat tires
- No water, no mixing. Use right from the container
- Extra slippery to help mount tires with stiff beads
- Makes tire mounting faster and easier
- Approved by major rubber companies



Why demand Dill?

Safety Risk Evaluations of Lower Quality Products

Dill valves are widely used by OEMs and fleets focused on consistent quality; but what about other aftermarket valves?



Cracked grommet during ozone test



Leaking valve during cold temperature testing

Lower cost valves often lack the quality control to have consistent material properties.

What does this mean?

To reduce costs, some imported valves replace key elements with substitutes such as zinc, nickel, silicon, and tin. These "DIY" alloys do not adhere to established material composition or performance standards, such as those set by ASTM.

Why does this matter?

Inconsistent material can lead to significant performance variations from lot to lot, affecting brittleness, strength, and resistance to corrosion.



Chrome Hi-Performance Valve

Perfect for Custom Wheels

Chrome plated valve and sealing cap. Especially suited to custom wheels. Includes grommets for .453" and .625" passenger car wheels.



5991B
462-00800
3/4"
\$1.56 ea.

Enkei Valves

- A high performance "No Show" type chrome plated valve that installs from the outside
- A rubber washer and nut are on the inside
- Fits .453" diameter hole



Ascot No.	McGee No.	Description	Price
462-06010	TR6010	3/4" Length, Standard	\$2.08
462-06020	TR6020	Bent at 45° Angle	\$2.48
462-06030	TR6030	1-1/4" Length, Standard	\$2.95
462-06040	TR6040	1-3/4" Length, Standard	\$5.15

Quality valves assure trouble free service!

TR416 Clamp-In Tubeless Tire Valves

- Nickel plated metal valves can be installed in all passenger cars, light trucks and industrial rims with .453" or .625" valve holes
- Rubber grommet forms a seal when valve is clamped to rim by tightening hex nut
- Maximum inflation pressure is 130 psi
- Includes 2 rubber grommets

3640 - 1/4"

Ascot No.	McGee No.	Eff. Length	Price
462-00416	TR416 (3640)	1-1/4"	\$1.37
461-01416	TR416L (3641)	2"	\$1.69

Radial Commander Valve For 15° Disc Wheels

- 23° bend clamp-down valve for .625" valve hole
- Bend allows clearance of brake drum for tire service

\$2.19 ea.

Ascot No.	Part No.	Description
462-01147	N1147	Radial Commander Valve Dill



Metric Rim Hole Valve MS Series

(9.7mm Valve Hole)

468-00707

- Some imported trucks will have steel wheels that incorporate the 9.7mm valve hole (.390")

Recommend installation torque 100 in - lbs



McGee No	Ascot No	ETRTO	Bend	A	B	Price (ea.)
60MS00			0	2-3/8"		\$4.95
60MS27	462-06027		27°	1-3/16"	1-3/16"	\$3.97
70MS27	462-07025	V3-20-5	27°	1-3/16"	1-9/16"	\$3.11
80MS27	462-08027	V3-20-7	27°	1-3/16"	2"	\$3.65
90MS27	462-09027	V3-20-4	27°	1-3/16"	2-3/8"	\$3.77
115MS27	462-11527	V3-20-6	27°	1-3/16"	3-3/8"	\$3.76
41MS00	462-04100	V3-20-1	STR	1-3/16"	—	\$3.17
70MS7	468-00707	—	7°	1-19/32"	1-1/8"	\$3.19
70MS7 - Long thread for thicker wheels on motor coaches						
V3221		V3-22-1	45°	30mm	28mm	\$3.37

Tubeless Valves for Aluminum Disc Wheels

For drop-center aluminum disc wheels with 5/8" bottom valve hole



Ascot No.	McGee No..	Effective Length	Price ea.
463-00509	TR509	4-3/4" Straight	\$3.78
463-00510	TR510	5-1/2" Straight	\$3.43
463-00511	TR511	4-1/4" Straight	\$4.25
468-05093	TR509-3	Replacement Rubber Grommet	

Ford "F" Series Truck Valve

- Ford "F" series with dual wheels
- Chrome finish
- Alcoa aluminum 16" wheels
- Dual seal cap included
- Front and rear wheels

Ascot No.	McGee No.	Description
462-01600	VS902WP	Ford "F" Series Valve



\$3.36 ea.

Ford "F" Series Truck Valve

- Ford "F" series with dual wheels
- Includes dual seal cap
- Accuride steel 16" x 6" wheels
- Front and rear wheels
- Nickel finish

\$3.14 ea.

Ascot No.	McGee No.	Description
462-02416	TR416MC	Ford "F" Series Valve



23° bend



Hex bottom for tightening



Tubeless Truck Clamp-in Valves Dill - with U.S.A. made grommet!

Straight clamp-in valves used on both demountable and non-demountable rims. For .625" diameter valve hole.



McGee #	Effective Length	Cost Each	100 Ea.
TR500	2"	\$1.84	\$1.71
TR501	1 1/2"	\$1.82	\$1.70
TR501IV	1 1/2"	\$1.31	\$1.26
TR570	3 1/8"	\$1.89	\$1.60
TR571	3 3/8"	\$1.99	\$1.69
TR572	3 3/4"	\$2.05	\$1.74
TR572IV	3 3/4"	\$1.82	\$1.50
TR57213	13° bend in valve	\$2.50	—
TR573	4 3/8"	\$2.55	\$2.18
TR573IV		\$2.36	\$2.00
TR57313	13° bend in valve	\$2.14	—
TR573HT13	13° bend in valve high temp	\$5.49	—
TR574	5"	\$2.57	\$2.11
TR575	1-1/8"	\$1.67	\$1.55

IV is Ascot branded product.

Remember - Bending a valve after it is in the wheel will often ruin the grommet and will cause a valve leak.

Tire Valves - 540 Series

O-ring seal valves for Alcoa truck wheel (9.7MM Valve Hole)

Many production Alcoa aluminum wheels are manufactured with a 9.7MM valve hole that requires an O-Ring tire valve. Valves have a high temperature resistant O-Ring and a heavy duty metal valve cap.

Ask for the premier USA made Dill!



Valve TR No.	A Height	B Length	C Bend Angle	Price ea.	100 ea.
TR542	1.25			\$3.34	\$3.17
TR543	2.40	-	-	\$3.66	\$3.47
TR543D	.98	1.38	60°	\$3.75	\$3.56
TR543E	.98	1.38	75°	\$4.24	\$4.01
TR544	2.90	-	-	\$3.34	\$3.17
TR544D	.98	1.94	60°	\$3.30	\$3.12
TR545	3.50	-	-	\$3.38	\$3.20
TR545DL	3.50	Dill	--	\$5.65	\$5.36
TR545D	.98	2.6	60°	\$4.49	\$4.26
TR546	4.25	-	-	\$6.19	\$5.87
TR546D	.98	3.35	60°	\$3.14	\$2.97
TR546E	.98	3.35	75°	\$4.52	\$4.28
TR546G	.98	3.35	36°	\$4.90	\$4.64

High Pressure Snap-In Valves — Dill OE

- Tubeless snap-in type valves for high pressure applications
- Maximum cold inflation pressure is 80 psi
- For .453" or .625" rim holes
- Do not use on tire rims that exceed .205" in thickness



Ascot No.	TR No.	Eff. Length	Valve Hole Dia.	Sale Price
461-00600	TR600HP	1.27"	.453"	\$.91
461-00602	TR602HP	2"	.453"	\$1.62
461-00801	TR801HP	1.25"	.625"	\$.98
461-00802	TR802HP	2"	.625"	\$1.95

TR600HPV import - 100 each - \$.60 ea - TR600HPC Chrome Available

Chrome-Sleeve Snap-in Type Tubeless Tire Valves

- Standard snap-in type tubeless tire valves are fitted with an attractively designed hexagon valve cap and chrome sleeve to cover the valve stem area
- Available in two lengths to fit .453" valve holes.

Ascot No.	Mfg. No.	Eff. Length	Price
461-41211	TR412SC	7/8"	\$.74 ea
461-41311	TR413SC	1-1/4"	\$.87 ea
461-41811	TR418SC	2"	\$1.13 ea



Truck Grommets



McGee #	Rim #	Fits	Used On
5953	RG-15	.625 Valve Hole	TV-500 Series, TV-570 Series
RG15S	RG-15	.625 Valve Hole	TV-500 Series, TV-570 Series red grommet 288°
G160	RG-22	.812 Valve Hole	H-41, T-81, T-30, DS-385, DS210
5093	RG-46	.625 Valve Hole	TV-509, 510, 511
G174	RG-48	.625 Valve Hole	TV-513, 515
G170S		.625 Valve Hole	Heat-Resistant Grommet for TV-570 Series (400°) green
59765	RG-54	.453 Valve Hole	TV-416, 416L, 6008
525	RG-39	.625 Valve Hole	TV-416, 416L
G550	RG-70	.9975 Valve Hole	Fits TV-550 Series - 400°
0330	RG-60		TR-540 Series Valves - 400°

Metric Clamp-In Valves 550 Series



TR555D import \$3.50 each!
Use TR550 series for better seal than TR540 series

Popular on all new Alcoa wheels!

Compatible with aluminum wheel designs with .389 valve hole.

- Viton grommets offer a greater temperature range, a better seal, and a longer service life — Maximum temperature 250°
- Easier installation with screwdriver slot.
- Recommend installation torque 45 in - lbs.



McGee #	A	B	C	Price ea.	100 ea.
TR553	2.31	-	-	\$5.24	\$4.91
TR553C	0.93	1.38	45°	\$5.24	\$4.91
TR553E	.98	1.38	75°	\$5.52	\$5.18
TR554D	.98	1.94	60°	\$4.24	\$3.98
TR555DL	.98	2.6	60°	\$3.90	\$3.66
TR555E	.98	2.6	75°	\$4.56	\$4.27

1/8" Rim Hole Cleaning Brush

44078 \$7.49

Available in 1/4" and 3/8" also!



Dill - OE - Stem Snap-In Tubeless Tire Valves



Made with special rubber compound to resist ozone damage and prevent premature deterioration caused by rim hole compression, heat, cold. Maximum inflation pressure is 65 P.S.I.

Why Dill?

Valve Hole	McGee No.	Effective Length	Standard Pack Box	50 Pk Price
.453	TR412	7/8"	500	\$.40 ea.
.453"	TR413	1 1/4"	500	\$.42 ea.
.453"	TR414	1 1/2"	500	\$.51 ea.
.625"	TR415	1 1/2"	500	\$.55 ea.
.453"	TR418	2"	500	\$.66 ea.
.453"	TR423	2 1/2"	500	\$.86 ea.
.625"	TR425	2"	500	\$.96 ea.

Special prices on boxes of 500 each.



413 414 418 423 415 425



Machine Year Month Day

Snap-in tire valves have become a commodity even though they are critical in maintaining the correct tire pressure. As questions arise regarding the life of rubber components and as an effort to provide traceability for this product line, Dill provides a solution! Each Dill stem has the production data etched on it!

Economical import stems TR413IV - \$.28 ea. TR418IV - \$.39 ea.

Stow & Go™ 4-Way HD Lug Wrench - 35636

- The Stow & Go™ 4-Way HD Lug Wrench folds to save space in your trunk and locks into place for easy use.
- Sliding arms give extra leverage for removing lug nuts.
- Made of heavy duty and durable alloy steel.
- 17mm, 19mm, 21mm sockets, and 1/2" square drive adaptor to be used with other sockets.
- 16" in length.



\$26.54

Tool Lock Ring Forklift Set - 32129

- Helps prevent injury – easier to keep hands safely outside of press cage!



\$293.95

Duck-Billed Bead Breaking Wedges – Fiberglass Handled



Ascot No.	McGee No.	Handle No.	Length	Weight	Price
424-35429	TG11E	TG11EH	32"	9.1 Lbs.	\$144.99

ASBBH5 - Hammer Bead Breaking HD 5 LB \$82.99

- A unique tire & wheel service hammer used for separating tires from wheel rims
- 75 times stronger than wood and fiberglass w/lifetime shaft warranty!
- Made of steel bars that run all the way through
- Patented heat treatment process ensures uniform hardness on all faces including edges, thus preventing mushrooming of head & accidents due to chipping the handle and locked with the hammer head using steel locking plates ensuring the head never becomes dislodged or loose
- Ergonomic rubber grip handle absorbs vibrations & reduces fatigue
- Dual injected fiberglass ergonomic rubber grip handles absorb vibrations and reduces fatigue that will not break
- Head is induction case hardened for extended life
- Made in India

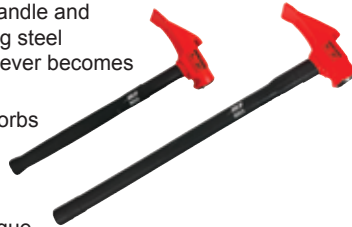

See it in action

ASBBH10 - HAMMER BEAD BREAKING HD 10 LB \$139.99

Golden Tool Tubeless Truck Tire Mount/ Demount Tool

- Demounts/mounts 17.5" to 24.5" tires
- Use on all tubeless truck tires including super single/duplex tires, radial and bias
- Eliminates the need to lift tire and rim to remove the bottom bead, preventing possible strain or even serious injury



Ascot No.	McGee No.	Description	Price
448-00100	TNT100	Complete Tool	\$574.99
448-12320	44812320	Economy Complete Tool (AME)	\$399.99

TNT200 for super singles

Universal Demount Tool Kit 20415

- Safe, simple, fast, economical, and the most universal tire demounting system on the market
- Works as a hand-held tire machine and shines where other tools fall short
- Tackles the hard 19.5 reverse hubs and grader tires and can be used on all tire sizes from 10" ATV tires and up
- Great for agricultural tires, one-piece grader, loader, forestry and backhoe tires

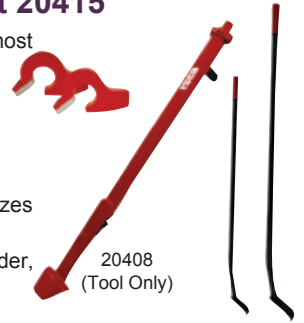

20408 - Tool Demount Pneutek Impact Driven (Tool Only)

Ascot No.	Mfg. No.	Description	Price
402-20415	20415	Tool Demount Pneutek Impact Driven Kit	\$974.99

T115 Truck Tire Changing Stand \$302.13

Stand handles wheels or open rims 16.5" to 24". Double-slide adjustment with locking device prevents twisting so it stays aligned with the wheel or rim. Stand is the ideal height for driving off beads or demounting tires.



T950 IronMan™ Ergonomic Wheel Lifting Bar \$96.84

Reduces back strain. Easily and safely lift heavy, awkward truck tire and wheel assemblies. Extremely useful in outdoor conditions – when truck tire and wheel assemblies can become wet and slippery. Standard sizes including 22.5" and 24.5" wheels, plus European (which have 1" lug holes), Super Wide and even the Super Single

Lt Spare Tire Removal Tool Set

- Lower spare tire in 10 seconds
- Eliminates hunt for customer's tool
- Hanger included
- Do not use impact wrench
- 7 piece kit
- Replacement tools available



\$89.99 #96090A

Tubeless Tire Irons

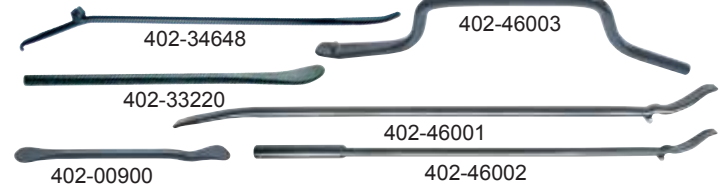

- Use C bar with the B extension bar for easier use on large, wide-base truck tires
- Use on standard and large truck tires, including industrial, farm, buses and tractors

Ascot No.	McGee No.	Description	Length	Price
402-00900	T9A	Small Tire Mount/Demount	9"	\$23.04
402-33220	T20A	Curved Tire Mount/Demount Spoon	30"	\$30.81
402-33219	T19A	Straight Spoon	30"	\$32.10
	T45A	Tubeless Mount/Demount	37"	\$65.31
402-34645	T45AC	Classic T45 Truck Tire Tubless Iron	37"	\$78.56
402-45004	T45HD	HD Truck Tire Tubless Iron	41"	\$96.78
402-46001	T46A	Med. Duty Mount/Demount Iron	36"	\$65.41
402-46002	T46B	Mount/Demount Iron	36"	\$77.66
402-46003	T46C	Offset Bar For Deep Well Tires	22"	\$53.76
402-33223	T23A	Lock Ring Tool	30"	\$31.30
402-34648	T48A	Lock Ring Tool	37"	\$63.73
	T21R	Curved Mount/Demount Spoon	18"	\$30.08

Pricing subject to tariff related changes

“Combi” Tire Bead Breaker

- Works on a single, two and three-piece truck, agricultural and earthmover tire/rim
- Breaks beads in seconds using 10,000 lbs. of force
- No screws, bolts or attachments
- “Combi” bead breaker will not work on five-piece earth mover giant wheel/rim



422-11010



422-16200

The 16200 upgrade kit can be added to Combi Bead Breakers in order to convert the tool so that it can work on new 3 piece wheels.

Ascot No.	McGee No.	Description	Price
422-11010	10101	Bead Breaker	\$658.99
422-11020	11020	Modified “Combi” Tire Bead Breaker	\$1,199.99
422-16200	16200	Conversion Kit for Combi Bead Breaker	\$514.99

Modified “Combi” Tire Bead Breaker Kit

- Modified 11010, the most popular tool for breaking beads on all agriculture wheels
- Most affordable bead breaker for new 3 piece wheel assemblies
- Modified jaw and feet allow for larger grab on larger wheel assembly



15920 - Pump
(98050- RPG Vers - **\$433.33**)

422-12020 (full kit)

Ascot No.	McGee No.	Description	Price
422-12020	12020	Bead Breaker Kit. INCLUDES: 11010 Bead Breaker, 15920 Pump and 16040 Hose Assembly	\$1,899.99

11076 - Original Maxi Bead Breaker

- Lightweight aluminum reduces weight by 40%
- Adjustable clamp allows for a perfect fit - regardless of the size of wheel
- Unit delivers 10 tons of force
- 2.75” (7 cm) stroke breaks beads often with only one “bite”
- Weight 31 lbs (14.1 kg) (Competitive to IMT1000)



Bead breaker pump chart



11076

\$2,199.99

55- and 100-Ton Aluminum Rams

Get the strength of a steel ram but with about half the weight. These single-acting, spring-return rams are easily carried around the shop, or into the field for on-the-vehicle repairs. They are ideal for truck axle correction, trailer frame straightening, general vehicle maintenance, and heavy-duty lifting.



13000AME



AJ506B

McGee No.	Capacity	Low Ht.	Raised Ht.	Wt	Price
AJ506B (13120)	55-ton	12.25”	18.25”	29 lbs	\$1,149.99 (base included)
13000AME	100-ton	11”	17.5”	53 lbs	\$2,199.99 (base not included)

1005LOM Service Truck Lockout Kit - \$154.99

McGee Company has the right tools when you need them. Now stocking 1005LOM Service Truck Lockout kit to keep people safe and avoid operating vehicles when they shouldn't be.

- Durable latch case that is super small!
- Reorder parts whenever to add to or replenish.
- Safety red items in case to draw attention.
- Contains Steering wheel cover, do not operate tags, padlock, steel hasp, and glad hand lock.



Other vehicle lockout kits available

Service Truck Packages and Cribbing by Service Truck Packages



OTR Inflation/Deflation Kit 24855



Tool Identification Chart by Rim



Hy-Flo Hydraulic Coupler

- Lightweight yet durable - 3/8” couplers
- Includes ram and hose portions
- Interchanges with OTC, Power Team, AME & ESCO hydraulic products

10600 Set

10606 10605

AHP20H



Ascot No.	McGee No.	Description	Price
318-09795	10600	Hy-Flo Hydraulic Coupler Set (9795)	\$49.99
318-09796	10606	Ram Female Half (9796)	\$25.99
318-0978	10605	Hose Male Half (9798)	\$14.99
318-04960	AHP20H	Nylon Core Synthetic Fiber Reinforced 8ft x 3/8” & half coupler 10605	\$77.13

Air Reducer with 6” Whip Hose

- Maintains tool's recommended working air pressure
- Tamper-proof preset value, 110 PSI
- Assist in lengthening the life of hydraulic pumps & lifting equipment
- Ideal for all hydraulic tools to extend their life



10601k

\$44.99

Jack Plate

14464 12x12x1” Jack Plate
D1818 18x18x1” Jack Plate available

14464- \$114.99

14464



11500-3-Step Tool For OTR \$189.99

- Eliminates risk to technician by allowing to keep fingers outside of gap between rim and bead seat band
- Large T-handle for easy rotation
- Stepped design allows for 3 different stages (1”, 2”, and 3”)

NEW



Hydraulic Rams

Used to push off rear rim flange and tire bead on earthmover wheels

- For all earthmover tires, trucks and perfect for construction



422-10303

422-10302

422-10301

Mfg. No.	Cap. (Tons)	Collapsed Height	Stroke	Price
10301	10	4-3/4”	2-1/8”	\$259.99
10302	10	6-3/4”	4”	\$269.99
10303	10	9-3/4”	6-1/8”	\$289.99

WHEEL ATTACHING HARDWARE

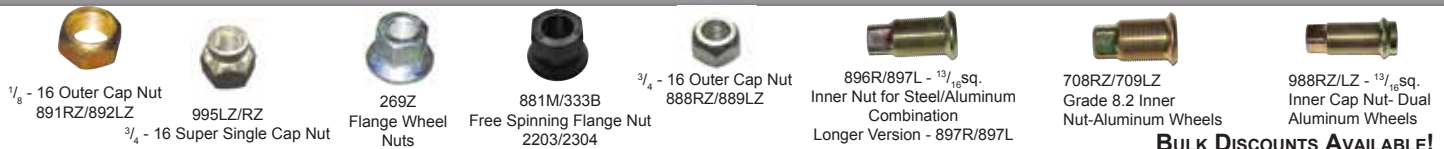

BULK DISCOUNTS AVAILABLE!

McGee No.	Mfg. No.	Similar To:	Sale Price
891RZ (RH)	GL-2001	Budd-37891/2	Euclid-5552-R/L \$1.68
892LZ (LH)	GL-2002	Nuturn-W-13/14	Batco-13-3012-R/L \$1.68
888RZ (RH)	GL-2101	Budd-37888/9	Euclid-5652-R/L \$2.48
889LZ (LH)	GL-2102	Nuturn-W-15/16	Batco-13-3013-R/L \$2.48
995RZ (RH)	GL-2103	Alcoa/Euclid-5995R	Leland W-506 \$7.00
995LZ (LH)	GL-2104	Alcoa/Euclid-5995L	Leland W-507 \$7.00
881M	GL-2302	(1 1/2 Hex) M.W. 88881	\$5.29
333B	GL-2301	(1 5/16 Hex) Budd 106333	\$3.15
Metric Outer Nuts			
304R	GL-2009	Hino-9004-21112	Isuzu-1-4233-023 \$6.40
304L	GL-2010	(Inner Thread = M30-1.5)	\$6.40

McGee No.	Mfg. No.	Similar To:	Sale Price
896R	GL-1003	Budd-35336/7	Euclid-5735 R/L \$4.60
896L	GL-1004	Nuturn-W107/108	Batco-13-3007-R/L \$4.60
897R	GL-1005	Budd-22621/2	Euclid-5568 R/L \$4.70
897L	GL-1006	Nuturn-W105/106	Batco-13-3006-R/L \$4.70
988RZ (RH)	GL-1011	Alcoa-5988-R/L	Nuturn-W-486/7 \$5.50
988LZ (LH)	GL-1012	Euclid - 5988-R/L	Batco 13-3026-R/L \$5.50
Grade 8.2			
708RZ (RH)	GL-1001	Euclid-7895R/L	Budd-10708/9 \$2.38
709LZ (LH)	GL-1002	BWP-M128/9	Batco-13-3032R/L \$2.38
Metric			
306R	GL-1009	Hino-9004-23101	Isuzu-1-42335-005 \$8.99
306L	GL-1010	(M20 Inner & M30 Outer Threads)	\$8.99

TWS22 and TWS14



Alcoa Rim Flange Gauge 000700



See them in action

492-02278	TWS22	Truck Wheel Stud Installer - Fits studs up to 7/8" (22mm)	\$12.07
492-14916	TWS-14	Vehicle Wheel Stud Installer - Fits studs up to 7/16" (14mm)	\$12.07

3-Piece Twist Socket Lug Nut Removal System

- Removal of damaged 3/4" and 19mm, 13/16" and 21mm lug nuts
- Two dual-sided twist sockets have a fluted design which gives the sockets a tight grip to remove the most difficult locking and damaged lug nuts from the socket
- Works with 1/2" impact gun or breaker bar for service calls
- Includes an extractor punch



\$64.99

Wheel Stud Service Kit 493-91420 - \$279.99

- Works on most hubs for installation and removal.
- All sizes of studs.
- Installation done by pushing on the head, eliminating the need for threaded adapters.
- Reduces number of adapters required and damage to studs
- Remove and install 10 studs in only 10-15 minutes (compare to 20-30 minutes for more expensive competitive products).
- Can be powered with an impact wrench, no hydraulic power source required.
- No need to remove hub from vehicle.
- Reduces risk of damage to hubs, studs, and bearings when using tool.
- Similar to OTC 4295

STUD INSTALLERS AND REMOVERS

Ascot No.	Mfg. No.	Description
492-10134	X10-S134Z	3/4" - 10 Stud Installer
492-10158	X10-S158Z	5/8" - 11 Stud Installer
492-10180	2415	1-1/8" (13/16") Stud Remover
492-10340	X10-SR34B	3/4" Stud Remover
492-15000	X10-NR15B	1-1/2" Hex Nut Remover Kit - 3-Piece Kit
	30165	Dual Wheel Lug Stud Remover (combo of Rib Nut and Installer)



REPLACEMENT RIB NUTS

499-10180	X10-LN18B	1-1/8" (13/16") Rib Nut
499-10341	X10-LN34B	3/4" Rib Nut



HEAVY DUTY DRIVE-ON RIB-GRIP LUG-OFF KITS

499-10200	X10-LT20B	For Removing Damaged Inner Cap Nuts (1-1/8" Diam., 13/16" Square Head). Consists of 1 Drive-On Tool and 1 Rib Nut
499-10340	X10-LT34B	For Removing Damaged 3/4" Lug Studs. Consists of 1 Drive-On Tool and 1 Rib Nut
499-10660	X10-LT66B	Triple Duty Tool for Removing Damaged Budd Wheel Inner Cap Nuts, 3/4" and 5/8" Lug Studs. Consists of 1 Drive-On Tool and 3 Rib Nuts



Bulk discounts available



16PB Nut Loosener



#606 Oil Can

\$24.99

\$9.99 ea.

Hub-Centric Wheel Nuts

Extended threading allowing Skirt Nut to go down into Hub-Piloted Disc Wheel an extra 3/16" (5mm) into stud hole



Ascot No.	Mfg. No.	Description	Price
491-02906	GL-2906 333SN6	Haltec 6mm Sleeve Nut • Steel Steers	\$12.58
491-02919	GL-2919 333SN19	Haltec 19mm Sleeve Nut • Aluminum Steers • Steel/Steel Drives • Steel Outer/Aluminum Inner Drives	\$13.62
491-02928	GL-2928 333SN28	Haltec 28mm Sleeve Nut • HD Aluminum • Super Single • Wide Base • Aluminum Outer/Steel Inner Drives	\$14.65
491-02939	GL-2939 333SN39	Haltec 39mm Sleeve Nut • Dual Aluminum Drive Axle	\$15.70

Wheel Assembly with Standard Nut

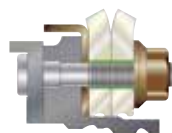

Void (Highlighted in Green) between stud and hole.

Wheel Assembly with Hub Centric Nut



Hub centric nut fills void between stud and hole.

Ascot No.	Description	Price
491-00133	33mm Hex X 1.5mm Thread Made in USA Two Piece Elongated Neck	\$18.99
491-01133	33mm Hex Nut Replaces Standard Nuts on 11.25" Hub Piloted Wheels	\$9.99
AS33SN	Skirt Nut Scored Top 33MM on 11.25" Hub Piloted Wheels	\$10.49

By filling the void between the stud hole, "clocking" is eliminated, and problems caused by clocking, such as wheel offs and wheel hub vibrations, are eliminated.

- Stops rim from shifting forwards or backwards
- Eliminates "clocking" caused by standard wheel nuts not filling wheel hole completely

Heavy Duty Truck Torque Wrench

168-12017 4AR1- **\$589.95**



- Robust construction gives accurate results to +/-4% even in arduous work conditions
- Supplied with a calibration certificate
- Break back action gives an unmistakable signal
- Break angle improves accuracy
- by reducing the possibility of overtightening
- Dual scaled, Nm and ft./lbs.
- New handle - more comfortable and guides operator's hand to correct position
- Now split for ease of transportation and storage

169-03013 - 1" Female x 13" Socket Extension! **\$59.99**

12299 - Adapter for Flex Hinge Torque Wrench 1" Sq Dr **\$70.95**

168-00425 **\$109.99**

- Dual direction with range: 25-250 ft./lb.
- Locking collar prevents accidental setting adjustment
- Easy to read laser marked scale
- Blow molded case with calibration certificate
- Overall length: 25"
- Made in Taiwan



The Importance of Accuracy: Understanding Torque Wrench Calibration

- Over time, normal wear and misuse can cause a torque wrench to lose its precision.
- A wrench that isn't properly calibrated may apply too much or too little force, increasing the risk of equipment malfunctions or safety hazards.
- Regular calibration is essential—most professionals suggest checking and adjusting your torque wrench at least once per year.
- Get with your McGee rep today to get a schedule going with automatic reminders and keep your company safe and your customers!



47501 - WRENCH TORQUE PRESET 1" DR X 475 FT/LB **\$744.99**

- Preset at 475 ft./lb.
- Massive 4-1/2' length for high torque applications
- Supplied with handy storage bag for sockets and extensions
- Both the wrench and the bag have reflective strips for safe highway night use
- Certified & Calibrated
- Made in Taiwan
- 2 piece version 14652P



Flex Hinge Torque Wrench

- 168-60011 (600FHTW)
- Robust construction
- Accurate results +/- 4%
- Adjustable torque settings
- Dual scaled, Ft./Lbs. & N.m.
- Durable storage case
- Every wrench is supplied with calibration certificate
- 2 adapters included: 3/4" to 1"; 3/4 to 3/4"
- Similar to Norbar 12007 & 12007.01



\$399.95

168-60012 2-Piece Version Available



Made in Taiwan

FREE
2215TPG - THREAD
PITCH GAUGE 22 X
1.5MM w/purchase
600FHTW

Split-Beam Click Torque Wrenches



Made in the USA



- Extremely accurate: within 4% of reading from 20% of full scale to full scale
- Setting torque on adjustable wrenches is fast and easy because there is no spring tension on the adjustment knob
- Torque setting locks on adjustable wrenches for repetitive applications
- Wrench length designed to provide the leverage required for maximum torque applications. Also provides the needed reach for those hard to get at places.

EXTREMELY ACCURATE



Ascot No.	Part No.	Description	Ft./Lbs.	Price
168-03250	C3FR250F	1/2" Drive	250	\$259.99
168-05600	C5D600F	1" Drive	600	\$659.99

Micro-Adjustable Torque Wrench

Now! \$199.99

- Dual scale, calibrated dual direction
- Positive lock with spring loaded pull down lock ring
- Fast, accurate and easy to set
- Easy-to-read laser marked scale
- Ergonomic comfort-grip
- Most feature quick release buttons which provide good socket retention as well as easy socket removal
- Range: 50-250 ft./lbs.
- Accuracy: ± 4% clockwise ± 6% CCW of indicated value, CW, from 20% to 100% of full scale

DUAL SCALE



Ascot No.	Description
168-12250	1/2" Drive Micro-Adjustable Torque Wrench

CALIBRATED DUAL DIRECTION

60012 - Torque Wrench 2-Piece Flex Hinge 600FT/LB

(Ascot 168-60012) **\$474.99**

- Robust construction
- Accurate results +/- 4%
- Adjustable torque settings
- Dual scaled, Ft./Lbs. & N.m.
- Durable storage case
- Every wrench is supplied with calibration
- 2 Adapters included: 3/4" to 1"
- 3/4" to 3/4"
- Repair kit - 168-60112



601SB - TORQUE WRENCH PRESET 1" DR SPLIT BEAM 600 FT/LB **\$449.99**

- +/- 4% accuracy
- Non coil-spring mechanism, no need to return to zero after use, which results in longer tool life
- Knob-type torque adjustment for faster and energy saving efficiency
- Window scale with PR cushion handle is oil resistant
- Loud click sound and strong impulse when required torque is reached
- Certified & Calibrated and Made in Taiwan

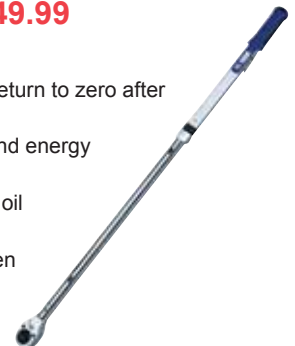

1/2" DR Deep Impact Sockets

Ascot #	McGee #	Description	Price
163-01018	1018MD	1/2" Drive x 18mm Deep	\$9.22
163-01019	1019MD	1/2" Drive x 19mm Deep	\$9.78
163-01021	1021MD	1/2" Drive x 21mm Deep	\$9.90
	1023MD	1/2" Drive x 23mm Deep	\$18.33
163-01024	1024D	1/2" Drive x 3/4" Deep	\$9.48
	1024MD	1/2" Drive x 24mm Deep	\$19.65
163-01026	1026D	1/2" Drive x 13/16" Deep	\$9.49
163-01032	1032MD	1/2" Drive x 32mm Deep	\$13.13
163-01034	1034D	1/2" Drive x 1-1/16" Deep	\$12.43
163-01036	1036D	1/2" Drive x 1-1/8" Deep	\$12.28
163-10143	1014MD	1/2" Drive x 14mm Deep	\$6.34
163-10163	1016MD	1/2" Drive x 16mm Deep	\$15.83
163-10171	1017MD	1/2" Drive x 17mm Deep	\$9.03
163-01018	1018MD	1/2" Drive x 18mm Deep	\$9.22
163-10222	1022MD	1/2" Drive x 22mm Deep	\$9.00
163-10281	1028D	1/2" Drive x 7/8" Deep	\$10.22
163-10300	1030D	1/2" Drive 15/16" Deep	\$9.95
	1030MD	1/2" Drive x 30mm Deep	\$28.30
163-11032	1032D	1/2" Drive x 1" Deep	\$17.17
	1033MD	1/2" Drive x 33mm Deep	\$25.84
163-01036	1036D	1/2" Drive x 1-1/8" Deep	\$12.28
	1042D	Hex 1/2" Drive x 1-5/16" Deep	\$30.88
163-01048	1048D	1/2" Drive x 1-1/2" Deep	\$23.48
	2133MD	12 Point 1/2" Drive x 33mm Deep	\$30.88

1/2" DR Flip Socket Sale!

STD. "Flip" Socket & Metric "Flip" Socket Double-end reversible impact socket. Fits passenger and light truck wheel nuts.

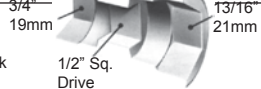

Ascot #	Part No.	Description	Price
	1291D	19mm-21mm Deep	\$12.60
167-12912	1291DT	Flip Thin 19mm and 21mm Thin, Deep	\$11.35
	1246D	3/4"-13/16" Deep	\$10.76
	1246DT	Extra thin 1246D	\$10.50
	1249D	7/8"-15/16" Deep	\$11.16
	0703T	7/8" x 15/16" Deep Thin Wall	\$14.68

1/2" DR Extra Thin Wall Impact Sockets

Ascot #	McGee #	Description	Price
163-10172	1017MDT	1/2" Drive x 17mm Extra Thin Wall	\$9.97
163-10174	1017MEDTM	1/2" Drive 17 mm Thin Wall Deep Mercedes Socket - Flower Petal	\$14.15
163-10183	1018MEDT	1/2" Drive X 18mm Extra Thin Wall	\$11.48
163-10191	1019MDT	1/2" Drive x 19mm Extra Thin Wall	\$11.02
163-10211	1021MDT	1/2" Drive x 21mm Extra Thin Wall	\$11.35
163-10223	1022MDT	1/2" Drive x 22mm Extra Thin Wall	\$13.39
163-10241	1024DT	1/2" Drive x 3/4" Extra Thin Wall	\$10.35
163-10282	1028DT	1/2" Drive x 7/8" Extra Thin Wall	\$23.80

3/4" DR Impact Sockets and #5 Spline DR Impact Sockets

Ascot #	McGee #	Description	Price
164-02026	2026S	3/4" Drive x 13/16" Square	\$19.97
164-02033	2033MD	3/4" Drive x 33mm Deep	\$23.85
166-04026	4026S	#5 Spline x 13/16" Square	\$59.97
166-04048	4048D	#5 Spline x 1-1/2" Deep w/Inside Lip	\$102.40



Don't see what you need?
Call us
1-800-525-8888

1" DR Square Impact Sockets

Ascot #	McGee #	Description	Price
165-03021	3021MS	1" Drive x 21mm Square	\$29.85
165-03026	3026S	1" Drive x 13/16" Square	\$22.84
165-03030	3030S	1" Drive x 15/16" Square	\$28.80

1" DR Combination Impact Sockets

Ascot #	McGee #	Description	Price
165-03323	3323C	1" Drive 1-1/2" Hex x 13/16" Square	\$45.05
165-03321	3321MC	1" Drive 41mm x 21mm Square	\$52.25

1" DR 1-1/2" Budd Wheel Impact Socket

Ascot #	McGee #	Description	Price
165-30481	3048D	1" Drive x 1-1/2" Deep w/Inside Lip	\$43.15
165-30482	3048DR	1" Drive x 1-1/2" Deep - Standard	\$40.50
	3048DT	1" Drive x 1-1/2" Deep - Thin	\$80.18

1" DR Metric Impact Sockets

Ascot #	McGee #	Description	Price
165-30302	3030MD	1" Drive x 30mm Deep	\$35.82
165-03033	3033MD	1" Drive x 33mm Deep	\$39.69
	4036MD	1" Drive x 36mm Deep	\$61.30
165-30381	3038MD	1" Drive x 38mm Deep	\$39.36
165-03041	3041MD	1" Drive x 41mm Deep	\$43.32
165-30410	3041MDT	1" Drive x 41mm Deep Thin Wall	\$56.96

1" DR SAE Impact Sockets

Ascot #	McGee #	Description	Price
165-03042	3042D	1" Drive x 1-5/16" Deep	\$38.48
	3046D	1" Drive x 1-7/16" Deep	\$33.50
165-03052	3052D	1" Drive. x 1-5/8" Deep	\$38.77
165-03056	3056D	1" Drive x 1-3/4" Deep	\$45.51
165-30321	3032D	1" Drive x 1" Deep	\$46.08
165-30380	3038D	1" Drive x 1-3/16" Deep	\$36.33
165-30401	3040D	1" Drive x 1-1/4" Deep	\$38.35
165-30402	3040DT	1" Drive x 1-1/4" Deep Thin Wall	\$71.43
165-03042	3042D	1" Drive x 15/16" Deep	\$38.48
165-30420	3042DT	1" Drive x 15/16" Deep Thin	\$47.18
165-03052	3052D	1" Drive x 1-5/8" Deep	\$38.78

Impact Extensions & Adapters

Ascot #	McGee #	Description	Price
169-01003	1003E	1/2" Drive x 3" L Extension	\$8.81
169-01005	1005E	1/2" Drive x 5" Extension	\$12.62
169-01020	1020A	1/2" Drive Female x 3/4" Male Adapt.	\$11.96
169-02006	2006E	3/4" Drive x 6" Extension	\$28.86
169-02010	2010ASC	3/4" Drive Female x 1/2" Male Adapt.	\$19.35
169-02030	2030A	Adapter 3/4" Drive Female to 1" Male	\$23.20
169-03013	03013	1" Drive x 13" Extension	\$69.11
169-03020	3020A	1" Drive Female x 3/4" Male Adapt.	\$29.93
169-04010	5008A	#5 Spline Female x 3/4" Male Adapt.	\$49.72

CUSTOM INFLATION SYSTEMS & SERVICE TRUCK PACKAGES 9

Fleet Solutions from McGee Company

Auto Inflators save time and money. Proper inflation creates longer tire wear and increased fuel mileage. These self-calibrating units are accurate to +/- .03 psi. Can be used as a reference point to calibrate hand held gauges.

Allows remote control of the inflation process, allowing the technician to avoid the "blast zone" during inflation.



LET US DESIGN
A CUSTOM
INSTALLATION
FOR YOUR
SHOP

MHB110 Magnetic Hook Hose \$8.99

- Extend the life of hoses by keeping them out of harm's way
- Keeps your space organized removing tripping hazards
- 17-40 lbs capacity
- Easy add to your existing tire cages



MHA100 - Tire Inflator Digital Flatematic \$299.99

- Presetable
- Inflation Range: 0-174 psi
- Accurate to: ± 0.2 psi

BEST



726026293E - Inflator Digital Euro 2' Hose \$99.99

- Inflation Range: 3-174 psi
- Accurate to: ± 1psi

BETTER



47711237 - Digital Inflation Gauge 6' Hose w/Clip-On Chuck \$84.99

- Inflation Range: 0-174 psi
- Accurate to: ± 1.2 psi

GOOD



Complete Truck Service Package featuring Quincy Powered Compressor



Complete Truck Service Package

**As low as
\$5,699.99!**

*Pricing variable
due to compressor

McGee #STP10

Includes these items:

- 13HP Champion or Quincy Compressor with Honda engine - HGR73H or G413H30HCB
 - Electric Start
 - Automatic Idle
 - Fuel Pump
 - Air Gauge
 - Easy Access Tank Drain
- 10 Piece Truck Socket Set - 3190
 - 13/16" Square, 7/8" hex, 13/16" hex, 1" hex, 1-1/16" hex, 1-1/2" hex, 1-1/16" deep, 1-1/8" deep, 1-1/4" deep
 - Plus metal box
- 15517786 1" Square Drive Impact
- Dual Foot Air Chuck
- Truck Air Pressure Gauge
- 50 ft. 1/4" Air Hose
- 50 ft. 1/2" Air Hose
- Air Couplers
- 20-ton Hydraulic Jack

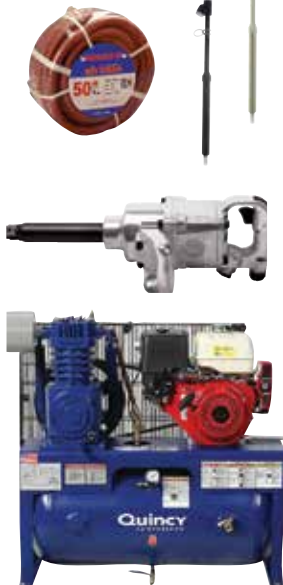

Steel surcharge may apply
Items may vary slightly from photos above.

Let McGee
Company design
the right kit for you
or customize your
own package from
large to small OTR!



Truck Package Components



Couplers & Nipples

- Steel plated couplers with hardened steel balls and stainless steel springs
- Plugs heat-treated to reduce wear on critical mating surfaces
- Interchange with Tru-Flate 10 and 100 type series as well as units produced by other manufacturers
- Maximum working pressure 300 psi.



Automotive Series



Ascot #	Dill No.	Milton No.	Amflo No.	McGee No.	Thread	NPT	Price
COUPLERS							
131-61523	D-13	785	C2	3504	Female	1/4"	\$6.23
131-61524	D-12	786	C1	3503	Male	1/4"	\$5.18
131-62523	D13R	--	--	3505	Female	1/4"	\$7.29
ADAPTER PLUGS							
131-61539	D-3C	784	CP2	3507	Female	1/4"	\$2.12
131-61538	D-2C	783	CP1	3506	Male	1/4"	\$1.82

Industrial Interchange

Ascot #	Dill No.	Milton No.	Amflo No.	McGee No.	Thread	NPT	Price
COUPLERS							
131-61573	102	715	C20	514212	Female	1/4"	\$5.99
131-61574	103	716	C21	514112	Male	1/4"	\$5.99
ADAPTER PLUGS							
131-61578	110	727	CP21	513811	Male	1/4"	\$1.64
131-61579	109	728	CP20	513911	Female	1/4"	\$1.98

Automotive Series



Ascot #	Dill No.	Milton No.	Amflo No.	McGee No.	Thread	NPT	Price
COUPLERS							
133-61563	D-17	1815	C10	3512	Female	1/2"	\$16.49
133-61564	D-16	1816	C9	3511	Male	1/2"	\$13.58
133-61471	D-17R	--	--	D17R	Female	1/2"	\$16.67
ADAPTER PLUGS							
133-61569	D-3F	1818	CP10	3514	Female	1/2"	\$6.55
133-61568	D-2F	1817	CP9	3513	Male	1/2"	\$6.31
133-61474	D-0F	1819	CP9-03	3537	Male	3/8"	\$3.87
133-01855	N/A	1855	N/A	1855MI	Male	1/4"	\$3.88

PREVOST 1/4"

Automotive Style Couplers

- One hand push button design - red
- Fits all 1/4" automotive style adapters
- Longer lasting

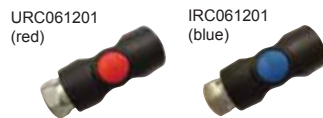

Constructed of high impact tough composite material. Smooth finish will not scratch and will not hang up like traditional couplers. Press the button and the downstream air releases, and when the coupler is discharged it automatically releases adapter or hose, preventing dangerous hose whip. Use with any automotive nipple. Industrial use with 513811, 513911, and 11E.

Mfr. No	Description - Automotive	Price
URC061201	1/4" FPT Automotive Coupler	\$31.99
URC061251	1/4" MPT Automotive Coupler	\$34.99

Use with industrial - blue button

Mfr. No	Description - Industrial	Price
IRC061201	1/4" FPT Industrial Coupler Female	\$32.99
IRC061202	1/4" x 3/8" FPT Industrial Coupler	\$31.99

13101750 - Safety Exhaust Coupler 5 in 1 1/4" NPT Body - \$32.99

- Designed to safely bleed off air pressure before releasing the connector eliminating hose whip
- Coupler remains connected to the plug while pressurized air is safely bled off
- Constructed of heavy-duty steel which is ideal for applications requiring a durable and long lasting pneumatic coupler
- Connects to all major interchanges: Industrial (M-style), High flow (v-style), automotive (t-style), Aro (A-style), and Lincoln (L-Style)



Air Line Couplers & Plugs:

Identification Chart

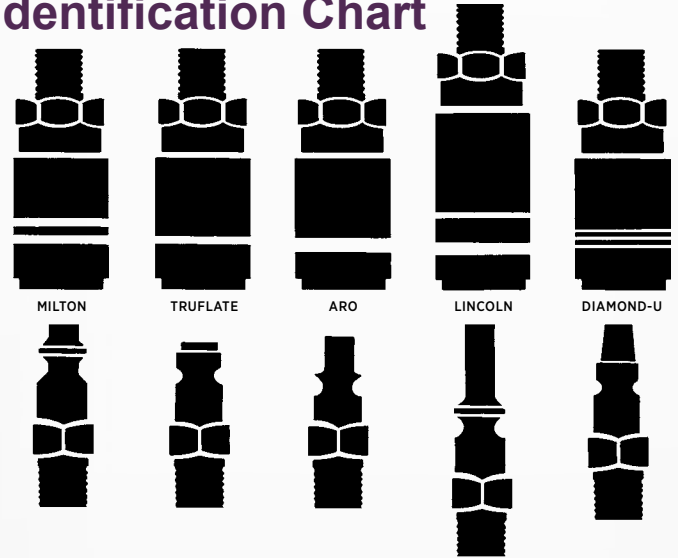

AMFLO NO.	MILTON NO.	DILL NO.	SCHRADER NO.
C1	786	D-12	3503
C2	785	D-13	3504
C2R	787	D-13R	3505
CP1	783	D-2C	3506
CP2	784	D-3C	3507
CP12	779	D-6C	3508
CP14	781	D-7CR	3510
CP1-302	--	D-5C	3533
1/4" "ARO" SPEED SERIES TYPE			
C38	775	8888	3526
CP37	777	8891	3529
CP38	778	8889	3530
1/4" INDUSTRIAL INTERCHANGE TYPE			
CP21	727	110	5138-11
CP20	728	109	5139-11
C21-103	719	--	5140-12
C21	716	103	5141-12
C20	715	102	5142-12
--	711	--	5142C-D
CP21-42	736	--	5223-11
CP21-103	733	115	5263-11
C20-23	718	--	5263-12
1/4" LINCOLN LONG STEM TYPE			
C28	790	123	3528
CP27	791	126	3531
CP28	792	125	3532
3/8" TRU-FLATE TYPE			
C5	1806	--	3515
C6	1805	D-15	3516
CP5	1807	D-2E	3517
CP6	1808	D-3E	3518
CP7	1809	D-0E	3519
CP8	1810	--	3520
C8	1803	D-15C	3521
3/8" INDUSTRIAL INTERCHANGE TYPE			
C26	1835	117	3541
CP25	1837	122	3542
CP26	1837	12	3543
1/2" TRU-FLATE TYPE			
C9	1818	D-16	3511
C10	1815	D-17	3512
C10R	--	D-17R	--
CP9	1817	D-2F	3513
CP10	1818	D-3F	3514
CP9-03	1819	D-0F	3537

Why do you need quality air gauges?

Keeping an eye on tire pressure is a critical part of regular inspection and maintenance.

Tire pressure is a critical function in many different ways. Underinflated (or grossly overinflated) tires don't handle safely, and if you find yourself in a "steer out of trouble" situation, improperly inflated tires can get you into a lot of trouble. Low tires heat up and can blow out, not only destroying the tire but also putting you in an accident-likely situation. Keeping tires properly inflated also makes sense from a dollars and sense perspective: Underinflated tires wear out more quickly. Overinflated tires can make the ride rough, and actually wear out suspension parts. And yes, fuel economy is really affected by tire inflation. The solution to these safety and money issues is as simple as regularly checking tire inflation, and for this you need an accurate tire pressure gauge.

GOOD 3% ACCURACY	BETTER 1-2% ACCURACY	BEST .5% ACCURACY
-------------------------------	-----------------------------------	--------------------------------

A QUICK GUIDELINE FOR OUR GAUGES IS SHOWN WITH THE PRODUCTS IN THE SECTIONS BELOW

PLEASE USE THIS GAUGE ACCURACY GUIDE AS A HELPFUL TOOL!

Master Air Pressure Station \$174.99

This station is used as a test pressure source for calibration of air gauges. Unit can be wall mounted on 1/2" npt pipe. TIA recommends regular calibration of truck tire gauges to maintain accuracy and assure proper tire inflation.



MAPS

1-2% ACCURACY

Pencil Gauges

RECOMMENDED FOR ALL TYPES OF VEHICLES

GA160 476-10160 20-120 PSI \$12.99	GA105 476-10105 10-50 PSI \$3.99
--	--

GOOD 3% ACCURACY	BETTER 1-2% ACCURACY	BEST .5% ACCURACY
-------------------------------	-----------------------------------	--------------------------------

1-2% ACCURACY

Truck Service Gauges

RECOMMENDED FOR ALL TYPES OF VEHICLES

GA155 476-10155 10-150 PSI \$16.99	GA165 476-10480 10-150 PSI \$11.70
--	--

GOOD 3% ACCURACY	BETTER 1-2% ACCURACY	BEST .5% ACCURACY
-------------------------------	-----------------------------------	--------------------------------

1-2% ACCURACY

Bayonet & Sight Glass Gauges

RECOMMENDED FOR ALL TYPES OF VEHICLES ASSEMBLED IN THE USA

I406M 477-00001 0-150 PSI \$59.99

GOOD 3% ACCURACY	BETTER 1-2% ACCURACY	BEST .5% ACCURACY
-------------------------------	-----------------------------------	--------------------------------

McGee Company offers free assembly of air hose to your required length!

Air Hose

- Rubber Air Hose
- 1/4", 3/8" & 1/2" Multi Purpose Air Hose Assemblies Smooth cover, 300 PSI W.P., 1,200 lb. burst. Limited oil resistance tube & cover. Red.



Mfg. No.	Description	Price
W64RJ25	25', 3/8" Hose, 1/4" MNPT	\$47.99
W64RJ50	50', 3/8" Hose, 1/4" MNPT	\$89.99
W84RJ25	25', 1/2" Hose, 1/2" MNPT	\$74.99
W84RJ50	50', 1/2" Hose, 1/2" MNPT	\$129.99

Prevost Flexair Hose

McGee No.	Description	Price
RISB3850	3/8" hose with Ind 1/4" fitting 50 ft	\$74.99
RUSB3850	3/8" hose with Auto 1/4" fitting 50 ft	\$74.99

Each hose includes 1/4" Prevost coupler and nipple

Coil Hoses

Unlike a standard hose that lies flat and can be stored by loosely wrapping it or mounting it on a hose reel. Recoil hoses are designed in a tight coil cord similar to a telephone cord, retracts when released, and compresses for easy storage. Our recoil air hoses are ideal for manufacturing plants or at home workshops that often prefer recoil hoses since they take up less space and can be quickly and easily stored.



McGee No.	Description	Length	Male NPT Both Ends	Price/ea.
14X14X14X25	Recoil Hose 1/4" x 25' w/ 1/4" Fitting Blue 150 PSI	25'	1/4"	\$31.99
14X14X14X12	Recoil Hose 1/4" x 12' w/ 1/4" Fitting Blue 150 PSI	12'	1/4"	\$19.99
6128A	Coil Hose 1/4" x 25' w/ 3/8" Swivel Fitting Blue	25'	3/8"	\$24.00
16751	Recoil Hose Repair Kit Nylon Hose Kit			\$18.48
16744	Recoil Hose 3/8" x 25' w/ 1/4" NPT Yellow	25'	3/8"	\$74.60

C-Series Low Pressure Hose Reels

- Reels ideally suited for plant maintenance, service trucks or other industrial functions
- Standard hose for air and water
- Single set screw to access spring casing
- Drive spring mechanism lubricated for life
- One piece combination latch, spring arbor, main bearing and spool support for fewer moving parts
- Brass swivel reduces corrosion potential
- Durable powder coated finish



Made in the USA



HOSETRACT®

Ascot No.	McGee No.	Operating Pressure	Hose ID	Hose Length	Ship Weight	Price
125-35000	LC350	300 psi	3/8"	50'	54 Lbs.	\$389.99
125-55000	LC550	300 psi	1/2"	50'	60 Lbs.	\$409.99

13101750 - Safety Exhaust Coupler 5 in 1 1/4" NPT Body - \$32.99

- Designed to safely bleed off air pressure before releasing the connector eliminating hose whip
- Coupler remains connected to the plug while pressurized air is safely bled off
- Constructed of heavy-duty steel which is ideal for applications requiring a durable and long lasting pneumatic coupler
- Connects to all major interchanges: Industrial (M-style), High flow (v-style), automotive (t-style), Aro (A-style), and Lincoln (L-style)



Have you ever wondered how to use big hoses with small fittings? Here is your answer!

514212 and 1855MI Combo!

Combine big hoses with small fittings with only two parts!

- **1855MI** - Nipple Automotive 1/2" w/1/4" MPT - **\$3.99**
- **514212** - Coupler Female and Interchange 1/4" FPT - **\$5.99**
- Moves you from 1/2" down to 1/4"



40703000 - Heavy Duty Tire Dolly **\$99.99**

- Perfect stud alignment on 8 to 10-hole Budd-type wheels
- Removes truck wheels and tires fast and easy
- Works with tires 23.5" to 43.5"



371-03321 AS3321 - Transmission Jack Telesc Two-Stage 1/2 Ton **\$999.99**

- Min Height: 37", Max Height: 76-3/8"
- Saddle Tilt (Forward/Backward): 29°/10° (Left/Right): 27.2°/46.8°
- Caster Size: 4"
- Foot activated raising and lowering pedals allow hands free operation
- Overload valve prevents jack from being used beyond its rated capacity
- Speed limiting valve ensures an automatic safe speed descent - not greater than 1" per second.
- "Hidden" hydraulic double pump system provides FAST lifting - under no load the jack can reach maximum height in 35 pumps
- Deluxe saddle with 2 angle adjustments - fore/aft and side to side - for maximum user flexibility.
- Includes a 59" tie down chain to secure the load.
- Chrome plated piston rod and pump core for longer service life.
- The grease fitting at the ram nut allows easy lubrication of the shafts.
- Heavy duty 4" steel swivel casters provide effortless maneuvering through the shop, 2 standard and 2 with locking mechanisms
- Wide channel steel base provides exceptional strength and stability



Accessories for Ascot Grey Service Jacks



Ascot No.	Mfg. No.	Description	Applicable Models
302-60129	AS5601-29-a-FH	Spring	2-Ton/3-Ton/4-Ton
302-61301	AS5613-01	Fixed Wheel Assy.	3-Ton
302-61401	AS5614-01	Seal Kit for Pump	3-Ton/4-Ton
302-61402	AS5614-02	Fixed Wheel Assy.	4-Ton
302-61403	AS5614-03	Pump	3-Ton/4-Ton
302-61404	AS5614-04	Caster	4-Ton

20-Ton Air/Hydraulic Bottle Jacks

- Thick jack base provides exceptional support and stability in severe conditions
- Quick-connect feature on air valve allows easy disconnect and connection of air hose & more compact storage

22-Ton Air/Hydraulic Truck Jack

- Large air motor provides an exceptional quick lifting experience
- Narrow chassis fits between tandem truck wheels
- Comes with three adapters in different sizes that cater to different working requirements



RPG
Basic Jack Maintenance



Why Use Jack Stands & Transmission Jack Safety Tips



ASK US ABOUT OUR TRANSMISSION AND UNDER HOIST JACKS TODAY! 1-800-525-8888

Universal Handle Protector - GHP01 **\$12.99**

- Made of a durable synthetic rubber
- Unique design ensures a tight fit on jack/tool handle without slippage
- Protects vehicles from scratches or dents caused by falling jack handles and unstable tools in the shop
- Keeps water/debris out of handle



3-Ton Jack Stands

- Ratchet height adjustment built within column
- Multi-level ductile iron ratchet bar adds strength and durability
- Sold in set of two

- 3-Ton – 30263030 **\$39.99**
- 6-Ton – 30263060 **\$79.99**
- 22-Ton – 30205622 **\$259.99**



30251005 10-Ton High Jack Stands (pair) **\$399.99**

- Pin-style stands with supporting range from 27.95" to 47.56" suitable for high-height applications
- HD tubular steel design provides stability and rigidity
- Multiple pin holes to allow easy adjustments
- Saddle with lugs for easy positioning of the load



302-02812 AS2812 - Jack Stand Underhoist Tripod 2-Ton **\$159.99**

- Min Height: 48-7/16", Max Height: 83-1/16"
- Saddle: 5-7/16" x 1-9/16"
- Base: 24-7/16" x 21-1/4"
- Underhoist stand is perfect for use with 2 or 4-post lifts, prevents tipping or rocking of the vehicle
- Heavy gauge steel frame prevents distortion or twisting
- Saddle comes with a removable rubber cover to protect load



Floor Jacks

- Double pump design for quick lifting and improved efficiency
- Heavy steel construction for maximum durability
- Equipped with a foot pedal to allow for hands free positioning
- 2-Ton, 2-1/2-Ton, 3-Ton, 3-1/2-Ton & 4-Ton capacity

Replacement Parts Available



1 Year Warranty on Ascot Jacks

Ascot No.	McGee No.	Description	Min. Hgt.	Max. Hgt.	Hyd. Lift Range	Exten. Screw	Chassis Size	Saddle Size	Handle Length	Ship Wt. (LBS)	Price
301-20221	AS2022S	20-Ton Short Air/Hydraulic Bottle Jack	7"	12-5/8"	3-3/8"	2-3/9"	N/A	N/A	9-3/8"	30.6	\$269.99
302-19150	AS1915	22-Ton Air/draulic Truck Jack	10-1/2"	21-1/8"	6-1/8"	4-1/2"	N/A	N/A	45-1/4"	101.9	\$529.99
302-05605	AS5605	Ascot 3-1/2-Ton Floor Jack	3-3/4"	20-1/2"	16-3/4"	N/A	27.2" x 14.25"	4-1/4"	47-7/8"	100	\$347.99
302-05614	AS5614	Ascot 4-Ton Floor Jck	4-3/8"	20-1/4"	16"	N/A	27.7" x 14.4"	4-1/4"	47-7/8"	102.5	\$379.99

22 Ton Air/Hyd Axle Jack with 3pc Ext Kit

New 565F1 from AFF - Now with reinforced frame

\$749.99

72200D from Norco - \$899.99

- Specially engineered air motor delivers fast and efficient operation
- Long t-handle design allows easy access to vehicles with long overhangs
- Large 8 inch diameter rubber wheels provide effortless travel in the shop or roadside
- Fully welded hydraulic pump and cylinder delivers maximum strength and leak free operation
- Heavy duty wiper seals protect the system from contaminants and ensures long service life
- Overload safety valve provides added operator safety



Capacity	Ram Lift	Low Height	High Height w/extensions	Length	Front Width	Rear Width
22 tons	4-3/4"	8-1/4"	21-1/2"	20-1/4"	6-15/16"	12-13/16"

Bottle Jacks

- Extension screw on some models
- Rust protection covering
- Uniweld construction
- 50% overload factor
- Fewer moving parts



MAG 925
\$10.99

ZN12	Jack Bottle Standard 12-Ton	\$129.99
ZN22	Jack Bottle Standard 22-Ton	\$209.99
ZNB12	Jack Bottle Low Profile 12 Ton	\$139.99
ZNB22	Jack Bottle Low Profile Screw Out Ext 22 Ton	\$219.99

20 Ton Capacity Air/Hydraulic Super Duty Bottle Jack

- AFF's most innovative and robust air/hydraulic bottle jack to date
- Redesigned air motor
- Super thick base to increase stability on every surface
- High-strength Steel Ram and cylinder with long ram guide for greater safety in off-center load conditions
- Welded Tank (threaded and screwed to the base) endures the rigors of in-service conditions and reduces risk of tilting out of the oil reservoir



Low	10.375	Lift	6.375
High	20.625	Base	5.75 x 9
Ship weight 45 lbs.			

5620SD	20-ton standard	\$379.99
5621SD	Low profile design	\$389.99
5630SD	30-ton super duty	\$489.99
76320B	20-ton Norco	\$489.99

14461 - Bottle Jack Air Hydraulic 20 Ton Low Pro \$364.99

- Cylinder is welded to the base, assuring strength and eliminating leaks
- Chromed pump piston and ram for added rust resistance
- Extension screw gives added height when necessary
- Super low minimum height for easy access



Norco 76320B Jack Bottle Air Hyd Standard 20 Ton \$489.99



3-1/2 Ton Professional Heavy Duty Double-Pumper Floor Jack

Model 350SS - \$399.99

This unit offers all the features of our model 350GT with additional speed and efficiency thanks to AFF's double-pumper advantage for quicker lifting.

- Lifts from 4" to 19-1/2"
- Pinned steel saddle (1-1/8" stud) with rubber pad for added vehicle protection
- Rear-mounted 2-3/4" swivel casters for ease of maneuverability
- One-piece 50-1/4" padded handle parks upright
- Ship weight 119 lbs.



Replacement Power unit 350SSKHU - **\$139.99**



400SS 4 Ton HD Floor Jack

\$420.99



- Twin hydraulic system for fast and efficient lifting
- Heavy duty pump, ram, and cylinders are precision machined and inspected to ensure long service life
- High grade U-cups seals and high-pressure plunger for maximum performance
- Rear mounted swivel casters for easy maneuverability
- Universal joint technology provides a more controlled descent
- Pinned and padded saddle for extra vehicle protection
- Flanged side plates for increased stability
- Integrated parts tray keeps small components from getting lost



14455 - Jack Bottle Air Hyd 20 Ton \$499.99

- Comes with free 14453 Jack plate 10x10" (\$100 value)
- Min: 9.7" max 18.5" Height
- Has Flexilla whip hose for longer life & max durability in all climates
- In-line regulator limits inlet pressure to 94 PSI



20-Ton 72090A \$729.99

INTENDED USE: Heavy duty truck, agricultural and heavy construction equipment. Ideal for loaded truck and trailer roadside service calls.

- Its light weight makes it perfect for mobile repair service.
- Long handle with 36-1/2" reach helps in positioning jack under vehicles with low overhang.
- Parkerized coating on pump piston, extension screw and extension adapters and chrome coated ram offer protection against rust.
- Removable extension screw with two 4" extension adapters (included) for added height.
- Self-retracting ram eliminates manual lowering.
- 5 1/4" diameter high impact composite wheels make maneuverability easy.
- Fast efficient air pump reduces lifting time and has a built-in relief mechanism which prevents the jack from being used beyond its maximum allowable capacity.
- Convenient push button air valve connected to an in-line filter prohibits contaminants from entering the air/hydraulic system.



Low Lift Height	8.625"	Screw Extension	2"
High Lift Height	22.75"	Base Size	9.25" x 17.25"
Stroke	4.125"	P.S.I. Range	100-130
		Shipping Weight	63 lbs.

Ask us about our no mar jack options!

1" Heavy Duty Air Impact Wrench

- Combines exceptional power, durability, and operator convenience
- Delivers 1450 ft./lbs. of maximum torque, with a 5000 RPM free speed and four-position power regulator 360° swivel inlet
- Available in 6" extended anvil and 6" extended #5 spline drive anvil for high production truck tire changing



155-02856



MCGEE EXCLUSIVE
while supplies last

Buy an IR285B6 and get a
FREE 5-piece socket set
(\$125 value)

Ascot No.	McGee No.	Description	Price
155-28560	IR285B	Standard Anvil	\$864.99
155-02856	IR285B6	6" Extended Anvil	\$499.99
156-28566	IR285BS6	#5 Spline Super Duty Anvil	\$819.99

1/2" CP77482 - Extreme Torque & Durability

- Most powerful 1/2" air wrench in its class
- Twin hammer grease clutch
- Ergonomic rubber handle
- Reinforced nose wings and back housing cap for longer durability
- Max Torque 1200 ft. lbs.
- 922 ft. lbs. Working Torque



CP77482

\$229.99

CP77412

\$169.99

- 10,000 RPM free speed
- 715 Ft/lbs max torque
- Super durable but 15% lighter than CP77362



1" Heavy Duty Air Impact Wrench

2140 ft.lbs 2900 Nm of maximum torque in reverse

- Pinless closed reinforced rocking dog impact mechanism
- Socket retainer ring combined with hole retainer
- Ergonomic side handle
- Full teasing trigger
- Regulator with integrated forward/reverse with 3-position power settings in both directions



155-77826

1" Heavy Duty Air Impact Wrench

ASCOT NO.	MCGEE NO.	PRICE
155-77826	CP77826	\$569.99
155-17782	CP7782SP6	\$749.99
	CP7782	\$729.99

286922HD - Impact Wrench SD Ext Anvil Cordless

1" DR \$1,489.99*

Bundles available!

- POWERSTATE Brushless Motor delivers up to 2,000 ft.-lbs of nut-busting torque & 1,900 ft.-lbs of fastening torque
- Install up to 200 1-1/4" bolts on a single battery
- M18 REDLITHIUM Battery Packs are compatible with all M18 tools
- The ONE-KEY Technology allows you to customize, track, and manage the impact wrench with the ability to set a repeatable torque output for maximum control
- Kit Includes:

- M18 FUEL 1" D-Handle High Torque Impact Wrench w/ ONE-KEY (2868-20)
- M18 REDLITHIUM HIGH OUTPUT HD12.0 Battery Pack (48-11-1812)
- M18 & M12 Rapid Charger (48-59-1808)
- Contractor Bag



Comes with low speed buffer while supplies last

153-02312
231XP2



1/2" Super Duty Extended Anvil

Air Impact Wrench \$184.99

This new model redefines the standards set by the classic IR231 model, with an enhanced Twin Hammer impact mechanism for more power and in-handle exhaust to direct air away from the operator and the work area.



With **FREE pink bootie** while supplies last



2235TIMAX2

Ascot No.	McGee No.	Description	Price
153-00231	IR231	Air Wrench 1/2" Dr Short Anvil	\$169.99
	2235TIMAX2	Air Wrench 1/2" Long Anvil Titanium	\$389.99
	2235QTIMAX2	1/2" Dr Quiet Air Wrench Long Anvil	\$334.99
	2235TIMAX	Air Wrench 1/2" Dr Short Anvil Titanium	\$282.99

Protect your investment with a boot. Ask your rep for the right size.



3/4" Maximum Power Impact Air Wrench

- Power: 2,000 ft.-lbs of nut busting torque w/ innovative pressure gauge improves productivity and prolongs product life
- Ability to quickly dial-in optimal power settings increases productivity and speed
- Cold-forged twin hammer impact mechanism and motor deliver more torque, durability, and efficiency
- Durability: Built to last and designed to withstand tough use in rugged environments; a two-year limited warranty is standard.
- 2-year warranty



INNOVATIVE PRESSURE GAUGE improves productivity and prolongs product life

6-VANE MOTOR delivers added power

2-YEAR WARRANTY

CONTROL
One-hand forward/reverse and feather-touch trigger provides, combined with the IR power regulation system, provide maximum control

Ascot No.	McGee No.	Description	Price
154-12145	2146QiMAX	Standard Anvil	\$654.99
154-22145	2146QiMAX3	3" Extended Anvil	\$804.99
154-32145	2146QiMax6	6" Extended Anvil	\$829.99
154-00261	IR261	HD 3/4" SD Wrench 1100 Ft/Lb Torq	\$625.99
154-02616	2616	3/4" Super Duty Air Impact w/6" Ext. Anvil	\$739.99

276922 - Impact Wrench SD Ext Anvil Cordless

1/2" DR \$645.49 *

- 4 CUSTOMIZABLE MODES: Provides multiple fastening torque outputs designed for sedans, light trucks and box trucks
- POWERSTATE BRUSHLESS MOTOR: Delivers up to 750 ft./lb. of fastening torque & 1,100 ft./lb. of nut-busting torque
- LONG MOTOR LIFE: POWERSTATE Brushless Motor delivers maximum power and long motor life
- Includes extra battery, case and charger.

*Stubby and bare tool available as well.



With **FREE 1/2" drill driver** while supplies last **\$150 value!**



*All prices subject to change

1/2" Drive Super Duty Air Impact Wrench

- 2" extended anvil
- Handle exhaust
- Free speed: 8000 RPM
- Maximum torque: 600 ft./lbs.
- Proven design and the most popular configuration in the tire service industry
- Powered by the durable and high performing twin hammer mechanism
- Net weight: 5.6 lbs.

\$134.99



153-23120
A2312

Protect your investment with bootie 231p32.

Ascot No.	McGee No.	Description
153-23120K	A2312KIT	1/2" Drive Air Impact Wrench - 2" Extended Anvil



Video on proper air tool maintenance; make your tools last!
(También en español)

<http://vimeo.com/212944966/>



1/2" Drive Composite Impact Wrench

- Convenient one-hand operated forward/reverse push button
- Four-setting torque adjustment switch
- 685 ft./lbs., 8000 RPM, 4.2 lbs
- Twin hammer mechanism provides smooth balance
- Energy efficient motor for maximum performance with precise speed control
- Swivel air inlet prevents hose from twisting

Now with forward/reverse button!



153-12260

Ascot No.	McGee No.	Description	Price
153-12260	A21312COM	1/2" Drive Composite Impact Wrench 2" Extended Anvil	\$149.99

1" Drive Impact Wrench A2856

- 6" extended anvil
- 3-position forward and reverse
- High efficiency 6-vane motor
- Pinless clutch mechanism
- Swoop back side handle for maneuverability/balance
- Working Torque 1,800-2,000
- Free Speed 5,000 RPM



Ascot No	McGee No	Description	Price
155-12856	A2856	1" Drive Super Duty Impact	\$399.99



231p32
\$8.95

175-10029
Set of 6 Rotor Blades

175-13457
Hammer Tune-Up Kit

Marvel Air Tool Oil

085 Marvel Air Tool Oil 32 Oz
18100085 - **\$9.99**

- Prevents rust formation while providing positive lubrication for smooth starting and long tool life
- Assures maximum performance by dissolving gum and sludge that cut down tool speed and reduce power output

8 oz. MM80R Available

085



1" Drive Mini Air Impact Wrench

- 6" Extended Anvil
- Free speed: 5000 RPM
- Maximum torque: 2000 ft/lbs
- Only 20 lbs – 50% less than the market leading 1" product, smallest and lightest 1" in the tire service industry
- Twin hammer clutch



155-26464

\$645.73

Ascot No.	McGee No.	Description
155-26464	15526464	1" Drive Mini Air Impact Wrench - 6" Extended Anvil

Full list of cutoffs and discs



417-12618



417-13003



Ascot No.	McGee No.	Description	Price
417-12618	12618	3" Green Zirconia 50Grit Grinding Disc 25/Box	\$39.99
417-13003	620TE-1	2" Surface Conditioning Discs: Brown (Coarse) 25/Box	\$23.99
417-10004	622TE-1	2" Surface Conditioning Discs: Maroon (Medium)	\$23.99

3" Cut-off Tool

157-10874

A874

\$69.99



1/4" Mini Angle Grinder

157-10875

A875

\$69.99



Super Red Pneumatic Air Tool Lubricant

- Dissolves gum and & varnish formation
- Ensures smoother starts
- Special rust & oxidation inhibitor
- Clean and free running
- 12 bottles per case
- Usable on piston or rotary type air tools



Ascot #	McGee #	Price
181-00406	0406	\$8.49
181-00404	16ATC	\$9.49

Kilfroast

❄️ Winter is here! ❄️

K16 Kilfroast Pneumatic Tool Anti-Freeze Lubricant, 16 Oz. bottle - 18184581 - **\$10.99**

- Prevents the freezing of pneumatic equipment caused by the formation of ice in and around exhaust ports and valves. Kilfroast absorbs the water in the airline. Is a semi-synthetic lubricant which has none of the drawbacks associated with normal oils.



6" EXTENDED ANVIL

1" Drive Super Duty Impact Wrench

\$449.99!



155-17786
A7786

Heavy Duty & High Torque!

- DURABLE: Steel end plates offering durability and extended life
- ADVANCED DESIGN: Proven motor and hammer technology; highly efficient air motor
- WORKING TORQUE RANGE: 370-1475 ft./lbs.
- 1 YEAR LIMITED WARRANTY on parts and workmanship
- COMPARE to CP77826

Professional Stitchers

- Corrugated ball bearing stitcher with hardened steel wheel and varnished wooden handle



Ascot No.	Part #	Description	Price
536-00001	30	1-1/2" Diameter x 1/16" Face	\$19.99

Gooseneck Stitchers

The newly designed GOOSENECK STITCHER has been proven to enhance stitching performance, providing ample pressure at all points on the tire without causing muscle fatigue for the tire technician.

Part No.	Description	Price
30GN	1-1/2" x 1/8"	\$9.99
6005GN	2" x 1/4"	\$24.99



Manual Tire Spreader

MS1 - 74.99

Ergonomic design to lessen muscle fatigue and increase productivity.



Pre-Buff Cleaner

PREMA Pre-Buff Cleaner is formulated to remove contaminants and silicone from the innerliner of the tire prior to buffing. Contains no ozone depleting chemicals.



Ascot No.	McGee No.	Description	Size	Price
505-00532	PPC32	Pre-Buff Cleaner (Flammable)	32 fl oz	\$20.52
505-00516	PPC16	Pre-Buff Cleaner (Aerosol)	16 fl oz	\$14.37

Prema Universal Repairs

PREMA Universal Repairs are designed for NAILHOLE REPAIRING of tubeless tires in the CROWN area only. Universal Repairs are available in round or square versions. Install with PREMA Ultra Fast Dry Vulcanizing Cement. Always fill the injury channel with the appropriate Prema repair material.



Ascot No.	McGee No.	Description	L (in.)	W (in.)	Qty/Box	Price
550-00502	PUR2	Universal Round 2	2 1/4	--	50	\$44.07
550-00522	PUS2	Universal Square 2	1 3/4	1 3/4	100	\$59.02
550-00533	PUS3	Universal Square 3	2 1/2	2 1/2	100	\$90.27
550-00534	PUS4	Universal Square 4	3	3	50	\$66.55

Ultra Fast Dry Vulcanizing Cement

PREMA Ultra Fast Dry Vulcanizing Cement is formulated to provide outstanding performance when used in conjunction with PREMA Repair Materials. Contains no ozone depleting chemicals.



Ascot No.	McGee No.	Description	Size	Price
501-00508	PFC8	Ultra Fast Dry Vulcanizing Cement (Flammable)	8 fl. oz.	\$15.19
501-00532	PFC32	Ultra Fast Dry Vulcanizing Cement (Flammable)	32 fl. oz.	\$38.00

Prema Radial Repairs - Passenger and Light Truck

PREMA Center-Over-Injury Repairs are designed for use in all radial tires. The PREMA Radial Repair is intended for use in HOT or COLD applications. PREMA Radial Repairs are designed for use in the crown, sidewall and shoulder of radial tires. Install with PREMA Ultra Fast Dry Vulcanizing Cement. Refer to the PREMA Repair Chart for proper selection of the repair unit. Always fill the injury channel with the appropriate Prema repair material.



Ascot No.	McGee No.	Description	L (in.)	W (in.)	# Plies	Qty/Box	Price
575-05109	PR109	Radial 109	3	1 3/4	1	20	\$30.81
575-05110	PR110	Radial 110	3 1/4	2 1/4	1	20	\$38.43
575-05111	PR110T	Radial 110	3 1/4	2 1/4	1	80	\$138.99
575-05112	PR112	Radial 112	4 3/4	3	1	10	\$29.96
575-15112	PR112B	Radial 112	4 3/4	3	1	40	\$117.87
575-05113	PR113	Radial 112HD	5	3 1/4	1	10	\$35.25
575-05114	PR114	Radial 114	5 1/4	3 1/2	1	10	\$47..50
575-05120	PR120	Radial 120	5	3 1/4	2	10	\$57.68
575-05135	PR135	Radial 135	7 1/2	5 1/2	4	10	\$161.03
575-05140	PR140	Radial 140	7 3/4	4 1/4	3	10	\$137.46

RAD 100 Series Radial Repair Units

RL110 Bulk 30 Per Bag - \$62.87

REMA RAD 100 Series center-over-injury repair units. Due to our fully-integrated blue bonding layer and center over injury design, REMA TIP TOP Radial-Ply repair units are suitable for use with all current vulcanizing systems. For best results, always select the corresponding REMA TIP TOP Stem insert unit.



Ascot No.	McGee No.	Patch Size Inches	(mm)	Qty/Box	Price
575-00110	RAD110	2 x 2-3/4	55 x 75	20	\$59.32
575-00115	RAD115	3-1/2 x 3	70 x 115	10	\$71.13
575-00120	RAD120	4-7/8 x 3	85 x 130	10	\$70.35

MCGPR6- Stainless Steel 6" Pocket Ruler with Clip and case \$6.29



- Has a sliding combination clip and depth gauge. 1/32" & 1/64" scales.
- Features a decimal equivalents chart of fractional inches on the back of the ruler.
- 1/2" (12.7mm) wide and 0.020" (0.5mm) thick.
- Measure injuries, tread, you name it!

Rema Minicombi Repair Units & Accessories

Part of Rema's renowned Blue Bonding System™, Minicombi features a metal pilot guide for easy installation and seating. Specially designed for tread area punctures on both radial and bias-ply tires, Minicombi should be used with Special Cement BL.



Ascot No.	McGee No.	REMA#	Description(Units/Box)	Price
581-67050	A3	A3	1/8" Minicombi A3 (50/Box)	\$139.99
581-67340	A6	A6	1/4" Minicombi A6 (40/Box)	\$167.99
581-68008	B8MC	B8-MC	5/16" Minicombi B8 (20)	\$118.99

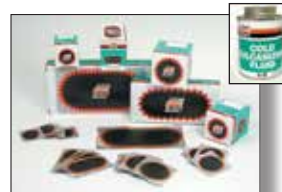

Rema tire tube patches are renowned for their easy application and extraordinary effectiveness. A unique rubber compound allows the patch to stretch evenly and equally in all directions upon inflation, assuring a reliable bond and minimal bulging in any service condition.

Ascot No.	McGee No.	Units Size	Per Box	Price
541-00410	1	1-1/2" Round	30	\$11.22
541-00420	2	1-3/4" Round	30	\$19.28
541-00430	3	2" Round	30	\$25.03

Patch should be 1/2-inch larger in both width and length than the injury.

Rema Tip Top Universal Patch

The Hole Solution™

The only patch you'll ever need for making a nail hole repair. For radial and bias ply passenger or truck tires.



Ascot No.	REMA No.	Injury Size	Qty.	Price
550-26707	UP3	Small Nailhole	100	\$79.53
550-26714	UP45	3/16" Nailhole	300	\$353.60
550-26721	UP6	1/4" Nailhole	50	\$86.96
550-26745	UP8	5/16" Nailhole	50	\$116.53

Premium Quality Chemical Vulcanizing Rubber Patches

Stems Repair Unit



Note: The JET Combi may only be used when the angle of the injury is LESS THAN 25°. If the injury angle is GREATER THAN 25°, repair with the appropriate two-piece stem and repair unit.



JSU - Combi

Repair Unit	Inch	mm	Cutter	Qty/Box	Price
SCU03	1/8	3	BU18T	24	\$27.08
SCU06	1/4	6	BU14T	24	\$33.96
SCU08	5/16	8	BU516N	24	\$40.58
SCU10	3/8	10	BU38T	10	\$34.25

AS5246 Razor Blade Scraper with Offset Handle \$9.99

- Strong, solid handle ideal for stripping paint, caulk, labels, overspray, gasket material, urethane and glue
- No sharpening needed, just replace the blade
- Protective cover keeps blade sharp and prevents cuts
- Includes one standard single edge blade
- RB100 Razor blades 100/bx \$7.49



Tire Denailer \$12.99

- Blade length 3" • Point diameter 5/16"
- Made in USA

Developed by a tire repairman to probe the injury and push the nail back through the tire. Probe has a recess at the tip to accept the point of a nail or other puncturing object.



Ascot No.	Mfg. No.	Description	Price
537-15227	23113IR	Insert Tool Open Needle	\$5.12
537-15230	20000	Insert T Handle Open Needle	\$25.19

REPCAB - JET REPAIR CABINET \$319.99

HD locking cabinet, 2 slide drawers on rollers and multiple shelves.

Everything you need for basic tire repair (optional equipment shown)

Includes:

- Innerliner Scraper
- Tire Repair Knife Round Point Flexible 4"
- Cement Tool Spiral
- Ball Bearing Stitcher 1-1/2" x 1/16" CS1
- Pre Buff Rubber Cleaner Aerosol 16 oz.
- Cement Vulcanizing Fast Dry 8 oz.
- Patch Rad Rect 2-3/4" x 2" SR110 20/Bx
- Sealer Innerliner Black 16 oz.
- Repair Cabinet Empty
- Patch Combi Unit SCU03 1/8" 24/Bx
- Patch Combi 1/4" SCU06 24/Bx
- Optional shown (Vacuum, Low-speed buffer, etc...)



Schedule your proper tire repair training with your rep today (includes certificate of completion)

McGee Company can help you determine the tire repair items needed to get started. Call for details!

Ask us about a tire repair cabinet to keep organized!



JET Radial Repairs - Passenger and Light Truck

JET Center-Over-Injury Repairs are designed for use in all radial tires. The JET Radial Repair is intended for use in HOT or COLD applications. JET Radial Repairs are designed for use in the crown area of radial tires. Install with JET Fast Dry Vulcanizing Cement.



Repair Unit	Size		Qty/Box	Price
	Inch	mm		
SR110	2 3/4 x 2	70 x 50	20	\$17.24
SR110H	3 1/4 x 2 3/8	80 x 60	10	\$10.83
SR112	4 3/8 x 2 1/2	110 x 65	10	\$13.38
SR114	5 3/4 x 3	145 x 75	10	\$22.38
SR120	5 x 3	125 x 75	10	\$21.67
SR122	6 7/8 x 2 3/8	175 x 80	10	\$29.11
SR124	8 1/4 x 3 3/8	210 x 85	10	\$38.15

Additional sizes - SR133, SR140, SR142

Universal repairs - nail hole injuries in crown area only. Advanced cushion gum for max adhesions.

Bias or Radial — Universal Repair Units - Square

Repair Unit	Inch	mm	Qty/Box	Price
SSA45	1 3/4 sq	45 sq	100	\$26.28
SSA55	2 1/8 sq	55 sq	80	\$28.15
SSA55T	2 1/8 sq	55 sq	100	\$38.83



AS - Square

Bias or Radial — Universal Repair Units - Round

Repair Unit	Inch	mm	Qty/Box	Price
SRA45	1 3/4	45	30	\$8.21
SRA45T	1 3/4	45	100	\$22.50
SRA55	2 1/8	55	30	\$10.13
SRA55T	2 1/8	55	100	\$28.60

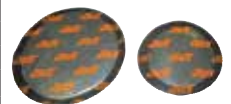

AR - Round

Vulcanized Tubeless Tire Repair Seals

- For emergency repair use only
- String repairs are not designed to be used in lieu of a permanent repair
- Repair a punctured tire in a matter of minutes
- Made from high-strength yarn and butyl rubber



362UBX

361UBX



McGee No.	Description	Qty/Box	Price
361UBX	4" Brown String Repair	50	\$13.99
362UBX	8" Brown String Repair	25	\$13.99
370UBX	7" Thin Black String Repair	50	\$15.70



- Clean out small injuries

Ascot No.	McGee No.	Description	Price
537-90150	261RT	Reamer	\$10.99

- Used to inspect injuries in tires and to remove small stones and debris



TMIT

1013P

Ascot No.	McGee No.	Description	Price
537-00001	1013P	Black Handle Awl	\$10.99
537-00083	TMIT	Tire Injury Measuring Tool Color Coded	\$10.99

#MTK Pouch \$42.99



Includes:

1 ea	GA115 Gauge 20-120 PSI
1 ea	MK White Markal
1 ea	1246D Flip Socket 3/4-13/16 Thin Wall
1 ea	1291DT Flip Socket 19mm-21mm
1 ea	595TM Tread Depth Gauge
1 ea	TL620 Core Tool

McGee Company does not recommend "temporary" tire repairs. All repairs should perform the function of filling or replacing the injured section as recommended by the RMA and other industry associations.

1/4" Shaft Tool

- Larger spheres, tapers & rotor saw are excellent for high-tread skiving.
- Smaller spheres chamfer around injuries on liner; don't take a chance on entrapped air!
- For section repair or high-tread repairs on radial truck tires & hot repair on nail injuries for retreaders.



Part #	Shape	Diameter	Coating
RH603	Sphere	7/8" (22.2mm)	Coarse (330)

2-1/2" All-Purpose Tire Buffing Wheel



- Our most popular wheel
- Covers more tire sizes than any other wheel
- Wide range of applications: Passenger/LT, Medium & Commercial Truck and Retreading

Part #	Diameter	Bore	Coating
RH107	2-1/2"	3/8-24	Fine (170)
RH109	2-1/2"	3/8-24	Medium (230)

1-1/4" High Performance/Low Profile Tire Buffing Wheel



- Buffs inner liner of low-aspect tires without damaging the bead area
- Machined-steel construction for smooth operation
- Internal thread; no exposed threads at top
- Superb control and comfortable use
- Preferred by many for any passenger or light truck repair

Part #	Diameter	Bore	Coating	Price
RH140	1-1/4"	3/8-24	Fine (170)	\$26.99
RH130	2"		60 Grit	\$17.99



Polyplugs-RH152 2 1/2" is most popular

- Compensates for mounting inaccuracies
- Improves wheel life
- Reduces vibration for smoother, quieter, more comfortable operation.



Don't forget to upgrade your Flared Contour Wheels with PolyPlug Inserts for an even better buffing experience!

**Ask us about our
RH130 and RH140
10% OFF special through the
end of December**

RH130 Rubberhog Flared Contour Wheel

- Proven Rubberhog shape
- Uses the Standard Grit coating for an economical solution
- Reduced aggressiveness for the less experienced user
- Much safer than black stones!

RH140 Rubberhog Flared Contour Wheel

- Proven Rubberhog shape
- Uses the Standard Grit coating for an economical solution
- Reduced aggressiveness for the less experienced user
- Much safer than black stones!

RPG Air Powered Tire Repair Vacuum

- Quick change from blow to vacuum function
- KIT INCLUDES: Plastic body gun, dust bag, 2 extension tubes, shop brush, flat tube, tiny tube



\$49.99

Aluminum body Rema version available



Ascot No.	Mfg. No.	Description
537-00003	VGB2	RPG Air Powered Tire Repair Vacuum

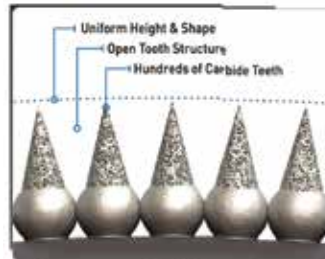

SSG Structured Carbide coatings and unique flared shape maximizes contact, producing a flat, level buffed surface!

Rubberhog carbides have a coating of randomly spaced sharp uniform conical teeth made from a very hard tungsten carbide material. It is the combination of the sharpness of the teeth, with the uniform height and shape of the teeth, that gives the Rubberhog rasp a fast, cool, superior buff texture resulting in a longer rasp service life.

Radiused Faced Rasps



Flat Faced Rasps



Non-Vented Radiused Cup Rasps

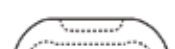

Vented & Non-Vented Contour Cup Rasp



Vented & Non-Vented Curved Cup Rasps



Vented Radiused Cup Rasps



Buffing Wheels



33



BC-1



539-00788



TCW21060SAEN

Ascot No.	McGee No.	Description	Price
539-00033	33	3/8" - 24 Arbor for mounting buffing wheels	\$13.99
539-10001	BC1	36 grit, round-nose buffer wheel, Tungsten Carbide 2 1/2" diameter — use on tires or tubes	\$5.99
538-01034	1034T	2" med. tooth buffing cone-Ideal for passenger inner liners	\$21.62
539-00788		(2) No. BC-1 buffing wheels mounted back-to-back on No. 33 Arbor (order item separately)	
	TCW21060SAEN	2" x 1" 3/8" SAE 60g rasp cup	\$24.99

Arbor & Grit:

Some of the rasps may be ordered in varying arbor holes and grit specifications.

Note: Use 36 grit and up for rubber finishing and cleaning. Use 16 grit for buffing, skiving, and cutting.

Wire Brushes

Ideal for buzzout repair of radials



535-08014



535-15463

**COPPER CENTER®
WIRE WHEEL
BRUSHES-WIRE FILL**

Ascot #	Mfg. #	Dia.	Wire Size	Arbor RPM	Hole	Price
535-15463	15463	2"	.0118"	20,000	1/2"-3/8"	\$9.99
535-15533	15533	3"	.006"	20,000	1/2"	\$14.99
535-15543	15543	3"	.008"	20,000	1/2"	\$12.99
535-15563	15563	3"	.0118"	20,000	1/2"-3/8"	\$11.99

Knotted Brushes

535-08014	08014	3"	.014"	20,000	1/2-3/8"	\$41.99
535-08034	08034	4"	.0118"	20,000	1/2-3/8"	\$45.99

Low Speed Tire Buffer with Quick Change Slip Chuck

15810873 - \$89.99

- Brass bushings provide performance and durability in tough working conditions
- Includes whip hose and exhaust hose
- Built in regulator
- Lock off throttle to prevent accidental start ups
- Rear exhaust directs air away from work area
- Q/C slip chuck for fast and easy change
- Equivalent to and has same dynamics as the CP 873k
- Overhose kit also available 175-00873



High Speed Tire Buffer Kit with Quick Change Chuck

15811871 - \$85.99

15810871 - with Jacobs - \$89.99

- Lock-off throttle
- Free speed 22,000 RPM
- Includes overhose kit



Channel Lock Cutters

- Precision made of fine polished, high carbon steel
- Distinctive CHANNEL LOCK Blue comfort grips

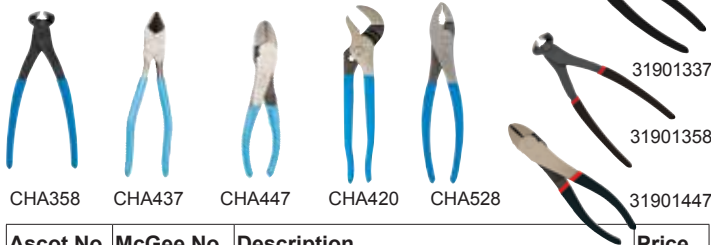

Ascot No.	McGee No.	Description	Price
319-01337	31901337	7" DIAGONAL CUTTING PLIERS	\$25.99
	CHA337	LAP JOINT DIAGONAL PLIERS CHANNEL-LOCK 7"	\$32.99
319-01358	31901358	8" CUTTING PLIER WITH END CUTTER	\$28.99
319-00358	CHA358	END CUTTER PLIERS CHANNELLOCK 7-8"	\$45.99
319-01447	31901447	7-3/4" CURVED DIAGONAL CUTTING PLIERS	\$26.99
319-00447	CHA447	LAP JOINT CUTTING PLIER CHANNELLOCK 8"	\$44.99
	CHA420	9-1/2" PLIERS GROOVE JOINT CHANNELLOCK	\$31.99
	CHA528	SLIP JOINT PLIERS HD CHANNELLOCK 8"	\$19.99

Tire Marking Crayons

- Bright Color On Any Tire. Will not melt, soften or rub off in the pocket. A quality crayon that marks on tires, tubes and rubber. Sold 12 per box.



Ascot No.	McGee No.	Color	Price
459-51420	51420	White	\$8.99
459-51422	51421	Yellow	\$8.99

The White Markal Crayon in use.

Paintstik® Marker Holder \$31.31



ASCOT NO.	MFG. NO.	COLOR
459-85100	102MK	6" Push-Button Metal Holder for B-Paintstik

Paintstik® Marker

Permanent, waterproof and fadeproof. Marks on wet tires, withstands retreading temperatures. Nontoxic, contains no lead. Sold 12 per box. Other colors available.



Ascot No.	McGee No.	Color	Price
459-80257	MKWhite	White	\$14.49
459-80258	MKYellow	Yellow	\$14.99

Overhose Kit & Connections



Ascot #	McGee #	Description	Price
173-09165	2500	Quick Change Chuck	\$34.99
173-09201	2510	1 1/16" x 3/8"-24 Chuck Adap. w/Washer & Nut	\$6.49
173-09202	2511JD	2 3/4" x 3/8"-24 Chuck Adap. w/Nut & Wheel Spacer	\$9.99
173-09211	2512JD	1 7/8" x 3/8"-24 Threaded Adap. w/Washer & Nut - Quick Change	\$4.30
173-09212	SLP9212	2 1/4" long x 3/8" - 24 Threaded Adap. w/Washer & Nut Quick Change	\$6.49
173-09213	2522	1 15/16" Adap. w/Set Screw for 1/8" Shank	\$3.38
173-09215	2523JD	1 15/16" Adapter w/Set Screw for 1/4" Shank	\$3.38
173-09216	SLP9216	1 15/16" Adapter w/Set Screw for 5/16" Shank	\$3.38
173-09400	SLP9400	Overhose Kit	\$34.99
173-00024	S1047XL	Adapter Quick Change XL Thread 3/8" x 1-3/4"	\$6.99
173-00025	S1047	Adapter Quick Change Long Thread 3/8" x 1"	\$7.49
173-00026	S1046D	Adapter Quick Change Double End	\$9.99
173-00027	S104138	3/8" Quick Change Adapter for 3/8" Burrs	\$11.99

BU14T - Taper Burr Carbide 1/4"

Double Cut

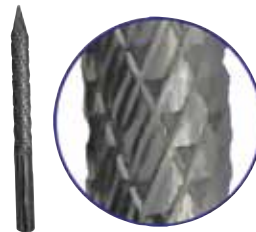

- The addition of the left hand flutes reduces the pulling action allowing better operator control
- It reduces the size of the chips and can be used at slower than normal speeds
- Standard on McGee carbide burrs!

MCGEE	TECH	REMA	PREMA	DISCRIPTION	McGee Price	MCGEE ADAPTER	TECH ADAPTER
BU18T	269	CC3	PCC1	1/8 TAPER CARBIDE CUTTER	\$10.49	2522	S1043
BU18R	283	CC45		1/8 ROUTER CARBIDE CUTTER	\$11.49	2522	S1043
BU18TL				1/8 TAPER LONG CARBIDE CUTTER	\$19.25	2522	S1043
BU316N				3/16 TAPER CARBIDE CUTTER	\$37.99	2523JD	S1044
BU14T	270P	CC6	PCC2	1/4 TAPER CARBIDE CUTTER	\$41.49	2523JD	S1044
BU14R	282			1/4 ROUTER CARBIDE CUTTER	\$31.99	2523JD	S1040
BU516N	271P	CC8	PCC3	5/16 TAPER CARBIDE CUTTER	\$59.99	SLP9216	S1041
BU38T	27138	CC10	PCC4	3/8 TAPER CARBIDE CUTTER	\$36.49	2523JD	S104138
BU716N				7/16 TAPER CARBIDE CUTTER	\$133.99	SLP9216	S1041
CC13	272	CC12		1/2 CARBIDE CUTTER	\$118.49	SLP9216	S1041/38
BU14B	286			1/4 CARBIDE BALL	\$25.99	2523JD	S1044
BU12B				1/2 CARBIDE BALL	\$33.49	2523JD	S1044



- Easy to use throw-in bag method
- Proven to increase fuel economy
- Color coded application chart
- Life time balance
- Balance whole wheel-end assembly not just tire and wheel
- Can be injected through valve stem
- Proven to extend tire life
- Flow-thru cap provided in 8oz bags and up
- TPMS friendly
- Download app to find tire size

How It Works

The balancing beads will be distributed around the tire as it begins to roll through centrifugal force. As the centrifugal force of the balance (heavy spot) increases and pulls up and down on the suspension, the beads will start to move in the opposite direction of the downward and upward through inertia. The beads continue to travel until the complete wheel assembly is balanced.

**Ask us
about our
motorcycle
applications**

Product	Description - Case Quantity Discounts	CASE QTY
45100013	INJECTOR PUMP FOR COUNTERACT	1
TIB4	4 OZ TOSS-IN BAG	92
TIB6	6 OZ TOSS-IN BAG	64
TIB8	8 OZ TOSS-IN BAG	52
TIB10	10 OZ TOSS IN BAG	40
TIB12	12 OZ TOSS IN BAG	36

New Nitrile Gloves



Part #	Description	Thickness	Color	Price BX	Case Price
8842	Micro Diamond Gloves 100/bx S	8mm	Orange	\$ 21.99	\$ 19.79
8843	Micro Diamond Gloves 100/bx M	8mm	Orange	\$ 21.99	\$ 19.79
8844	Micro Diamond Gloves 100/bx L	8mm	Orange	\$ 21.99	\$ 19.79
8845	Micro Diamond Gloves 90/bx XL	8mm	Orange	\$ 21.99	\$ 19.79
8846	Micro Diamond Gloves 90/bx XXL	8mm	Orange	\$ 22.99	\$ 20.69
8847	Micro Diamond Gloves 80/bx XXXL	8mm	Orange	\$ 20.99	\$ 18.89
14043	Micro Diamond Gloves 100/bx M	7mm	Red	\$ 18.99	\$ 17.09
14044	Micro Diamond Gloves 100/bx L	7mm	Red	\$ 18.99	\$ 17.09
14045	Micro Diamond Gloves 100/bx XL	7mm	Red	\$ 18.99	\$ 17.09
14046	Micro Diamond Gloves 90/bx XXL	7mm	Red	\$ 19.49	\$ 17.54
9843	Smooth gloves M 100/bx	6mm	Black	\$ 11.67	\$ 10.79
9844	Smooth gloves L 100/bx	6mm	Black	\$ 11.67	\$ 10.79
9845	Smooth gloves XL 100/bx	6mm	Black	\$ 11.67	\$ 10.79
9846	Smooth gloves XXL 100/bx	6mm	Black	\$ 12.76	\$ 11.69

Counteract Balancing Beads

Every bag includes:

- Measured bag of Balancing Beads
- Filtered vortex valve core
- Counteract valve cap
- 8oz bags and up include flow-thru cap.



Eco Balance Drop In Bags!

Eco Balance Beads are made of reusable and recyclable 99.9% tempered glass spheres. Our balancing beads are installed inside the tire, where they won't get knocked off and contaminate the environment like lead weights can.

10 oz. bag **As low as \$6.57**

10 oz. McGee 45101210



Scan QR code or visit www.counteractbalancing.com to find our application charts.



Cotton Weave Blue Poly Palm Glove

C122 - **\$2.99/pr**
\$1.99/pr. per doz



Black, Ultra Light Polyurethane Palm Glove

• Perfect for handling small parts

GP180ML
GP180XL



Gloves Black Polyester Textured

- CE certified
- Textured latex finish offers excellent grip & superior abrasion resistance
- 13-gauge polyester liner for a flexible fit
- Machine washable

GP180MLT - M/L **\$2.97/pr**
GP180LXLT - L/XL



Textured Grip

RPG Mechanic's Gloves

Black synthetic leather palm with small patches

Features blue spandex on back, neoprene on knuckle, 4cm wide elastic, hook & loop 396-10011 - **\$12.99**



Leather Palm Short Cuff

Part #112
\$4.49 pr.

Gemstone Protective Eyewear

- Clear

Y19CFC - **\$2.98 pr.**

Tinted Available (SG2Smoke)



Adhesive Wheel Weight Rolls

- Oversized white paper tape - easy peel
- Easy to tear by hand
- Available in grey steel or black steel
- 3 rolls per case
- WWR4 recommended stand for AVL



Ascot No.	McGee No.	Description	Case Price
484-51500	AVL315FeB	Black Steel Adhesive Roll: 1/4 oz. Segments (2880 Segments per case)	\$159.69
484-51501	AVL315FeS	Grey Steel Adhesive Roll: 1/4 oz. (2880 Segments per case)	\$156.44
484-61500	AVL415FeB	Black Steel Adhesive Roll: 1/2 oz. (1440 Segments per case)	\$159.69
484-61501	AVL415FeS	Grey Steel Adhesive Roll: 1/2 oz. (1440 Segments per case)	\$156.44
484-71500	AVL515FEB	Black Steel Adhesive Wheel Weight Roll - 1 oz. (690 Segments per case)	\$183.56
484-71501	AVL515FES	Grey Steel Adhesive Wheel Weight Roll - 1 oz. (690 Segments per case)	\$177.24



Scraper 71510
486-071510



486-71510	71510 Adhesive Wheel Weight Super Scraper Removes emblems, body side moldings and stick-on wheel weights.	\$9.90
486-33581	3358 KD Heavy Duty Weight Tool - Ideal for all weights, including coated.	\$28.95

Adhesive Wheel Weight Roll Stand

\$179.99

- All-metal construction
- Accommodates three rolls
- Floor mount
- Easy to assemble

486-31281
Adhesive Wheel Weight Roll Stand

Ascot No.	McGee No.	Description
486-31281	WWR3	Adhesive Wheel Weight 3 Roll Stand
486-31282	WWR4	Adhesive Wheel Weight 4 Roll Stand

48631285 Conversion Kit for Wheel Weight Roll Stand

Fits WWR3 and WWR4 AVL series to add two slots.

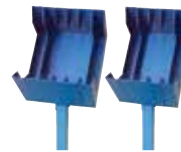

Ascot No.	Description	Price
48675032	Wheel Cleaner 32 Oz. Spray Bottle	\$13.99
48675017	Wheel Cleaner 1 Gallon Bottle	\$18.99

Saves time by having all of your rolls together

Wheel Cleaner

Stop Using Expensive Wheel Cleaning Solutions

- Water-Based
- Biodegradable
- Non-Petroleum
- Non-Toxic

A clean wheel is critical to good stick-on wheel weight adhesive.



Wheel Weight Adhesive Removal Tool

A143252 - \$69.95 Replacement pad - A1432526 only - \$8.99

- Lock-off trigger for added safety
- High torque motor to cut through stubborn wheel weight adhesive, body pinstripes, etc.
- Rubber-insulated housing for comfort
- High RPM to prevent pad from bogging down; 3,700 RPM free speed



Truck Tape-On Weights

	300360	.50 oz.	Standard Profile Quick Tab with Premium Tape	30 strips/box	Width: 1"	Lead 360 pcs	\$109.99
	300224FE	.50 oz.	Standard Profile Quick Tab with Premium Tape	24 strips/box	Width: 1"	Steel 224 pcs	\$49.99
	300224FE BLK	.50 oz.	Standard Profile Quick Tab with Premium Tape	24 strips/box	Width: 1"	Steel 224 pcs	\$62.99
	420FE	.50 oz.	Standard Profile	Roll	Width: 1"	Steel 640 pcs	\$145.99
	CL6	1 oz.	Standard Profile Quick Tab with Premium Tape	30 strips/box	Width 3/4"	Lead 180 pcs	\$114.95
	1184	1 oz.	Standard Profile with Premium Tape	18 strips	Width 3/4"	Steel 72 pcs	\$41.95
	48410300	1 oz.	Standard Profile with Economy Plastic Tape	36 strips	Width 3/4"	Steel 144 pcs	\$38.99
	48410301	1 oz.	Standard Profile with Economy Plastic Tape	36 strips	Width 3/4"	Steel 144 pcs	\$39.99
	CL12	2 oz.	Standard Profile Quick Tab with Premium Tape	8 strips/box	Width 1-1/4"	Lead 48 pcs	\$76.99
	FSF104C	2 oz.	Standard Profile with Plastic Tape	18 strips	Width 1-1/4"	Steel 54 pcs	\$38.95
	506FE15CW	1 oz.	Coated Cold Weather Tape	90/box	Width 1-1/4" Depth 5/32		\$62.72

Passenger Tape-on Weights Including Cold Weather Weights

	200576FE	.25 oz.	Low Profile Coated	3 oz./strip	48 strips/box	Width: 3/4" Depth: 1/8"	Steel 576 pcs	\$38.99
	200576FER Roll	.25 oz.	Low Profile Coated	Roll		Width: 3/4" Depth: 1/8"	Steel 700 pcs	\$53.99
	200576FE BLK	.25 oz.	Low Profile Premium Tape	3 oz./strip	48 strips/box	Width: 3/4" Depth: 1/8"	Steel 576 Seg/box	\$63.95
	FSF101CP	.25 oz.	Low Profile Economy Tape	3 oz./strip	48 strips/box	Width: 3/4" Depth: 1/8"	Steel 576 pcs	\$31.99
	320FE	.25 oz.	Premium Coated Steel	Roll	Double Tape	Width: 3/4" Depth: 1/8"	Steel 1272	\$119.99
	312FE52CW	.25 oz.	Low Profile Coated Cold Weather Tape		624/box	Width: 3/4"		\$68.99

Lug Nuts



Product	Desc1	Desc2	Price Ea	Box
LN01	LUG NUT 14MM X 2 BIG	BULGE FOR 13/16" HEX	\$3.11	\$62.20
LN02	LUG NUT 12MM X 1.5 BULGE	ACCURA,HONDA 3/4" HEX	\$1.18	\$23.60
LN03	LUG NUT 14MM X 1.5 2 PC	DODGE/JEEP/RAM 7/8" HEX	\$1.90	\$38.00
LN04	14MM X 1.50 2 PC	BULGE GM 7/8" HEX	\$2.30	\$46.00
LN05	9/16"-18 2 PC BULGE DODG	E/JEEP/RAM 7/8" HEX	\$1.90	\$38.00
LN06	1/2"-20 BULGE ACORN	13/16" HEX	\$1.18	\$23.60
LN07	12MM X 1.25 BULGE ACORN	13/16" HEX	\$1.18	\$23.60
LN08	12MM X 1.50 BULGE ACORN	13/16 HEX	\$1.18	\$23.60
LN09	12MM X 1.25 BULGE W/ WA	SHER-NISSAN-13/16" HEX	\$2.21	\$44.20
LN10T	LUG NUT 12MM 1.5 BULGE	W/ WASHER TOYOTA 13/16"	\$2.07	\$41.40
LN11	LUG NUT 14MM X 1.5 2 PC	MAG W/WASHER 7/8" HEX	\$3.67	\$73.40
LN12	LUG NUT 12MM X 1.5 CHR	SLER MAG 3/4" HEX	\$3.00	\$60.00
LN13	LUG NUT 1/2"-20 BULGE	ACORN 3/4"HEX	\$1.18	\$23.60
LN14	LUG NUT 12MM X 1.5 FORD	13/16" HEX	\$1.62	\$32.40
LN15	LUG NUT 12MM X 1.5	BULGE ACORN 3/4" HEX	\$1.18	\$23.60
LN16	LUG NUT 12MM X 1.25	BULGE ACORN 3/4" HEX	\$1.18	\$23.60
LN17	LUG NUT 12MM X 1.25	CONE LUG BOLT 19MM HEX	\$2.18	\$43.60
LN18	LUG NUT 14MM X 1.5	FORD 13/16" HEX	\$2.69	\$53.80
LN20	LUG NUT 14MM X 1.5	7 SPLINE	\$1.33	\$26.60
LN21	LUG NUT 12MM X 1.5	SPLINE 6-SIDED	\$1.27	\$25.40
LN22	LUG NUT 12 MM X 1.25	SPLINE 6-SIDED	\$1.02	\$20.40
LN23	LUG NUT 1/2" 20 SPLINE 6	SIDED BLACK	\$1.38	\$27.60
LN24	LUG NUT 14MM X 1.5 BLACK	BLUGE ACORN 3/4" 2 PC	\$1.49	\$29.80
LN25	LUG NUT 12MM X 1.5 BLACK	BLUGE ACORN 3/4" 2 PC	\$1.49	\$29.80
LN26	LUG NUT 12 MM X 1.5	SPLINE 6-SIDED BLACK	\$2.70	\$54.00
LN27	LUG NUT 12 MM X 1.5	2 PC SPLINE 6-SIDED	\$2.70	\$54.00
LN28	LUG NUT 12 MM X 1.5 2PC	OPEN END BLGE ACORN ZINC	\$0.85	\$17.00
LN29	LUG NUT 14 MM X 1.5 2PC	OPEN END BLGE ACORN ZINC	\$0.85	\$17.00
LN30	LUG NUT 1/2" 20 OPEN END	BULGE ACORN ZINC	\$0.85	\$17.00
LN31	LUG NUT 14MM X 1.5 FORD	HEAVY DUTY FORD	\$3.99	\$79.80
LN35	LUG NUT 12MM X 1.25	SUBARU 3/4" HEX	\$1.12	\$22.40
LN36	LUG NUT 12MM X 1.25 JEEP	ACORN SEAT LUG BOLT	\$1.90	\$38.00
LN37	LUG NUT 14MM X 1.5 FORD	13X16" HEX F250 F350	\$4.06	\$81.20
LN38	LUG NUT 12MM X 1.5	TOYOTA 13X16" HEX	\$2.38	\$47.60
LN39	LUG NUT 12MM X 1.5	BULGE ACORN 3/4" HEX	\$1.18	\$23.60
SA01	CAR ADPT FOR LUG NUTS 6-	SPLINE 3/4" & 13/16" DR	\$5.98	
SA02	TRK ADPT FOR LUG NUTS 7-	SPLINE 7/8" & 13/16" DR	\$5.98	
SA03	CAR ADPT FOR LUG NUTS 6-	SPLINE 19 MM & 21 MM DR	\$5.98	
LN185FF0B	LUG NUT 14MM X 1.5 FORD	13/16" HEX BLACK	\$3.38	\$67.60
LN188F0B	LUG NUT 14MM X 1.5 BLAC	K BLUGE ACORN 3/4" 2 PC	\$1.25	\$25.00
LN188LF0B	LUG NUT 14MM X 1.5 TRUCK	SPLINE 7-SIDED BLACK 1.9	\$1.58	\$31.60
LN189A0B	LUG NUT 1/2"-20MM 1.4	BLACK BULGE ACORN 3/4"	\$1.10	\$22.00
LN189LF0B	LUG NUT 14MM X 1.5 BLAC	K 2 PC 3/4" ACORN 1.9	\$1.10	\$22.00
LN289LF0C	LUG NUT 14MM X 1.5 2 PC	3/4" ACORN 1.9	\$1.05	\$21.00
LN289LFK6C	LUG NUT 14MM X 1.5	ACORN 1.89 HD LONG (sold by 24)	\$1.50	\$36.00
LN179L0Z	LUG NUT 9/16" X 18	ACORN ZINC OPEN END	\$0.80	\$16.00

32-Bin Metal Storage Cabinet

- CABINET SIZE: 33-3/4" (W) x 8-1/2" (D) x 19-1/4" (H)
- DRAWER SIZE: 4" (W) x 8-3/8" (D) x 4-1/2" (H)
- Keeps your tools and accessories organized and accessible
- Heavy-duty, welded steel construction provides strength and stability
- Hemmed bin fronts for retaining parts
- Mounting holes located in the top and bottom
- Shipped fully assembled and ready to use
- WEIGHT: 37 lbs.

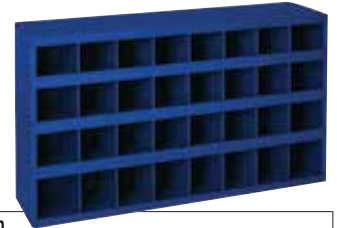
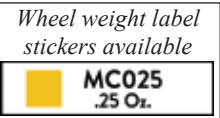

Ascot No.	Mfg. No.	Description
719-00032	32B	32-Bin Metal Storage Cabinet

18-Drawer Metal Storage Cabinet



Comes with stickers with lug nut labels to add!



Great for wheel weights or misc parts

- CABINET SIZE: 33-3/4" (W) x 11-3/4" (D) x 10-3/4" (H)
- DRAWER SIZE: 4-7/8" (W) x 11-1/4" (D) x 2-3/4" (H)
- Modular drawer design for efficiency and organization
- Heavy-duty, welded steel construction provides strength and stability
- Drawers feature stoppers to prevent accidental pulling or spilling
- Full-width handles and easy glide runners
- Shipped fully assembled and ready to use
- WEIGHT: 45 lbs.

Ascot No.	Mfg. No.	Description
719-00018	18D	18-Drawer Metal Storage Cabinet

10202312 Tesla Wheel Bolt Lock Socket Set \$99.99

- Applicable for installing and removing locks of Tesla series.
- Contents: #76, #77, #78, #79, #80, #81, #82, #83, #84, #85
- This tool enables you to permit servicing of customer vehicles, even customer has lost the key.
- Hand Tool use only, don't use impact wrench and air tool
- Made in Taiwan



12-Piece Tap and Die Set for Wheel Studs and Wheel Nuts

- Re-cutting and cleaning the threads is very simple
- The set includes all essential tools and adapters and comes in a blow mold case
- 4PC. DIE: m12x1.25,m12x1.5,m14x1.25,m14x1.5
- 4PC. TAP: m12x1.25,m12x1.5,m14x1.25, m14x1.5
- 1PC. tap holder (M12-M18)
- 1PC. die socket (Ø38 HEX, Ø36.5 ROUND)
- 1PC. screw pitch gauge
- 1PC. 1/2" sr. 25mm with C-ring socket

NEW



Ascot No.	Mfg. No.	Description	Price
319-00012	31900012	12-Pc Tap and Die Set for Wheel Studs and Wheel Nuts	\$139.99

INDIVIDUAL SOCKETS AVAILABLE

Locking Lug Master Key Set

The set was designed explicitly for the purpose of removing locking lug nuts on aftermarket wheels. The 16 piece set comes with both standard (SAE) and metric pieces that can be used on Spline, Star, Hex and Fluted Hex fasteners.

40201283 - \$129.99





81240, 81250, 81260, 81270, 81280, 81290, 81295

Front Adjustment range:

Camber $\pm 1.75^\circ$

Required: 1 per axle

**As Low as \$23.99
for 81250**

APPLICATIONS

See application charts, pages 7-70 for years.

81240 pr (10mm) Fiat

81250 pr (12mm)

Buick, Chevrolet, Cadillac, Daewoo, Dodge, Eagle, Fiat, Ford, Geo, GMC, Hyundai, Isuzu, Kia, Mazda, Mercury, Mitsubishi, Nissan, Olds, Plymouth, Pontiac, Porsche, Saab, Saturn, Suzuki, Toyota, Volkswagen, Volvo

81260 pr (14mm)

Acura, Buick, Chevrolet, Chrysler, Dodge, Ford, Honda, Hyundai, Infiniti, Jeep, Kia, Mazda, Mercedes Benz, Mitsubishi, Nissan, Olds, Pontiac, Plymouth, Saturn, Scion, Subaru, Toyota, Volvo

81270 pr (15mm) Lexus, Scion, Subaru, Toyota

81280 pr (16mm)

Acura, Buick, Cadillac, Chevrolet, Chrysler, Dodge, Eagle, Ford, Honda, Hyundai, Kia, Lincoln, Mazda, Mercury, Mitsubishi, Oldsmobile, Pontiac, Saturn, Toyota

81290 pr (17mm) Lexus, Pontiac, Scion, Toyota

81295 pr (18mm)

Acura, Honda

It is easy to find out if the camber kit that will fit your aftermarket strut with only two measurements:

EZ Cams™ make non-adjustable two bolt struts adjustable up to $\pm 1.75^\circ$ camber change. Head markings show where the cam is for maximum change and an easy-to-manipulate toothed washer lets you set positive or negative change. Simply remove the upper OE bolt, loosen the lower bolt, install and adjust the EZ Cam™ to the desired change and then tighten everything to specification. An easy fix for camber issues and a perfect companion sale for any strut job. Save time, money and effort by making aligning two bolt struts a one man job without grinding. Keep one of each in stock, measure the OE threads, replace the OE bolt with SPC's EZ Cams™ to make your alignment jobs fast and profitable.

Part No. 81250 (pr)
For replacement of 12mm bolts

Part No. 81260 (pr)
For replacement of 14mm bolts

Part No. 81270 (pr)
For replacement of 15mm bolts

Part No. 81280 (pr)
For replacement of 16mm bolts
This kit may also be used on GM vehicles equipped with aftermarket slotted struts with the addition of our adapter plate, #81286 included with cams.

Part No.	Cam Dia. (A)	Bolt Size (B)
35077	1.3" (33mm)	M14 x 80mm
82110	1.5" (38.1mm)	M16 x 80mm
83170	1.49 (37.85mm)	M14 x 80mm

EZ Cam™ XR

FOR DOMESTIC/IMPORT TWO BOLT STRUTS

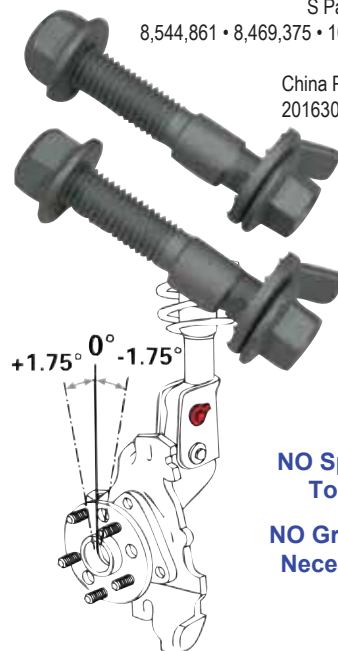

S Patent Nos.
8,544,861 • 8,469,375 • 10,450,005
D783,393
China Patent No.
201630012294.X

NO Special Tools

NO Grinding Necessary

Got Aftermarket Struts with a Slotted Hole? We have the answer!



EZ CAM™ XR

Spreader

37975 STEERING KNUCKLE SPREADER



Use this tool to safely and easily expand steering knuckles. This tool is perfect for single bolt strut vehicles. Pry bars can damage the knuckle, but this tool allows safe expansion with the tool adjustment nut. Designed to operate within a 4.4 - 10mm range, this expansion tool will fit most makes and models.

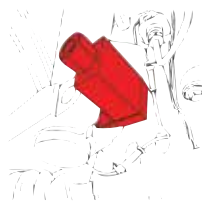

\$73.99

Truck Axle Shims

As Low as \$8.30 each

*10422 Alum

Ordering one Part# supplies **SIX SHIMS** in a box. When placing order spring pad length and width is needed.



	COST	COMPRESSION STRENGTH	HARDNESS
ALUMINUM ALLOY	\$\$	★★★	★★★★
ZINC ALLOY	\$\$\$	★★★★★	★★★★★

Specialty Products carries Truck Axle Caster Shims in three different alloys, giving the technician the opportunity to match price point and mechanical requirements to meet their customer's needs. Choose from Aluminum, ZINC. 36000 full kit available..

FasTrax™

36087

HENDRICKSON HD SHIMS

This shim kit will adjust the thrust angle on Hendrickson's 'walking beam' rear tandem axle suspension. Improve tire wear and handling by adjusting thrust angle from 0° to 3/8" in precise 1/32" increments.

REPLACES these OE kits-

Euclid Nos: E-9327, E-9328, E-9329

Hendrickson Nos: 50130-000, 50131-000, 50132-000

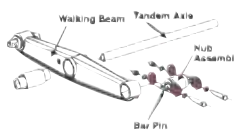

\$39.99

Adj. Range: 3/8" Required: 1 set per wheel Includes: 2 (two) five piece kits

ITS600 TPMS, Diagnostics, and Tire Service Tool

- Activates, reads and relearns all known sensors
- OBDII relearn for most vehicles with 99% coverage of OE sensors
- Copy By OBD sensor programming & four MX-Sensor program modes; batch program up to 20 MX-Sensors
- Includes wireless Bluetooth vehicle communication interface (VCI)
- Tire pressure placard value reset
- Read/Clear TPMS system codes & view live data
- Free Wi-Fi software updates for the life of the tool



60 Sensor Bundle
\$1,199.99
w/ITS600

ProUpgrade \$125

- Rapid VIN acquisition via optical VINScan
- QR Code Scan / Barcode Scan, Plate scan, Auto VIN detect and manual input
- Identify MMY and sensor OE part number via VIN decoding



TBE in action

Integrate with the TBE200 for:

- Precise laser measurement of tread depth & brake disc wear
- Create comprehensive Test Report w/ TPMS health, Tread depth, brake disc wear characteristics, & Repair tips

TBE200 **\$459.99**

Ask us about our competitor tool trade up program

McGee Exclusives



Buy 96 1sensor24 bag;
get a free TS900 tool*
(McGee TS900 to order)

*While supplies last

Sick of your technicians not being able to read tire DOT codes or read what they wrote down?



ITS600 is the first tool to scan DOT numbers for expiration and recall lookup!

TBE200 Video



ITS600 Video



46130100 - Pre-Programmed Tesla Bluetooth TPMS Sensor

- The MX-Sensor BLE is a pre-programmed Bluetooth Low Energy (BLE) sensor that offers "fit & go" capability for:
 - Tesla Model 3 2021-2023
 - Tesla Model S 2021-2023
 - Tesla Model X 2021-2023
 - Tesla Model Y 2020-2023
 - All Tesla models older than the years above use our standard Ascot by Autel MX Sensor 1-Sensor
- Built to meet or exceed industry standards and tested to endure extreme temperatures, the MX-Sensor BLE is also programmable with Autel tools for the latest BLE-equipped vehicles
- The MX-Sensor BLE is warranted for two years



Dill OE Tesla sensor available

\$54.99

Autel MX-Sensor Programmable Universal TPMS Single Sensor

Metal stems available in Black, Titanium, Chrome, & Rubber

- Combines 315MHz & 433MHz frequencies into a single sensor
- 98% vehicle coverage
- The exclusive MX-Sensor patented PRESS release valve allows rubber and metal valve stems to freely interchange by hand without requiring a tool
- Built to match or exceed OEM sensors in frequency strength and durability
- 100% ID cloneable with no relearn required
- Quickly update during installation with an Autel wireless programming tool



Ascot No.	McGee No.	Description	Price
461-20326	1-Sensor	Autel MX-Sensor Programmable Universal TPMS Single Sensor	\$27.99 Quantity breaks available

FREE SOFTWARE UPDATES



BASIC FUNCTIONS
EASY & FAST

- Activate All Known TPMS Sensors
- Read Sensor ID, Temperature, Pressure
- Read Sensor Battery Condition
- On-Tool OE Sensor Information
- Program MX-Sensor With 3 Programming Options
- Batch Program 1-16 MX-Sensors

\$499.99*

MaxiTPMS TS508WFK16

- 1 - Autel TS508 Complete TPMS Tool
- 4 - Metal Valve Stems
- 16 - 1Sensor TPMS Programmable Sensors
- Wifi Version Available



COMPLETE FUNCTIONS
POWERFUL

- Same TPMS Features as Quick Mode
- TPMS Status Screen - View System Faults
- Read & Clear TPMS DTCs
- On-Tool DTCs Description
- Program MX-Sensors by Copying ECU Sensor IDs
- On-Tool Relearn Procedure Guide
- Widest Vehicle Coverage For OBD Relearn
- Tire Pressure Placard Value Reset

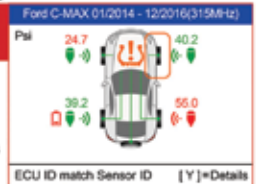

AUTEL TPMS TOOL

- The MaxiTPMS® TS508 is a new generation TPMS diagnostic & service tool specially designed to activate all known TPMS sensors, read TPMS sensor status, check TPMS system health condition, program MX-sensors and conduct TPMS relearn
- With Quick Mode and Advanced Mode options, you can save time and energy by choosing the most suitable way to complete TPMS work



TS508WFK

TPMS Profit Center

Remember, replacing the TPMS valve stem (snap-in rubber or clamp-in aluminum) or the TPMS service kit with each tire sale is done for the same reasons a traditional TR-413 snap-in is replaced with each new tire.

More information at mcgeecompany.com/stems



TPC
\$189.99



- McGee's top 7 stems
 - * 4 VS70
 - * 4 VS925
 - * 8 VS90
 - * 8 VS65
 - * 4 VS35
 - * 20 VS950
 - * 8 VS20
 - * 8 VS15
- Color coded for easy selection
- 52 stems
- Extra dividers to fit your needs
- Heavy duty protective organizing case

How much money are you leaving on the table by not doing TPMS?

	TR413 Valve Stem	TPMS Rebuild 9066k
ASSUMPTIONS	100 Tires per Week	100 Tires per Week
Cost to WD	\$ 0.29	\$ 4.84
Sell price	\$ 1.90	\$ 9.95
Profit per tire	\$ 1.61	\$ 5.11
Weekly profit	\$ 161.00	\$ 511.00
Annual profit (52 weeks)	\$ 8,372.00	\$ 26,572.00

A shop doing TPMS makes over **three** times the amount doing TPMS versus valves alone in addition to pushing their customers to a competitor. **Be TPMS smart**; let McGee Company train you and set you up with the tools to be successful.

REDI-Sensor™

Simple and Accurate

REDI-SENSOR MULTI-APPLICATION SENSOR

- Installs right out of the box • No programming required, saving you 8-10 minutes per vehicle • Reduces replacement sensor inventory • Adjustable valve stem design • Fits over 90% of the market



What's the difference between 5000 series and Redi?



WORKS WITH EXISTING MAJOR TPMS SCAN TOOLS:

If a shop has the tools to handle OE sensors, it's ready for REDI-Sensor. Unlike other sensors that require the purchase of specialized tools and software upgrades, no additional purchases, training or investments are needed with REDI-Sensor.

Ascot No.	McGee No.	Description	Price
461-07005	7005HPR	433MHZ REDI-SENSOR W/ VS-20 SNAP-IN VALVE	\$35.99
461-07006	7006HPR	315MHZ REDI-SENSOR W/ VS-20 SNAP-IN VALVE	\$35.99
461-07007	7007HP	315MHZ REDI-SENSOR W/ VS-70 CLAMP-IN	\$35.99
461-07008	7008HP	433MHZ REDI-SENSOR W/ VS-70 CLAMP-IN	\$35.99
461-05001	5001R	PRE-PROGRAMMED DILL SENSOR TPMS 433MHZ	\$35.99
	7006HP625	315MHZ REDI 7006HPR with 0.625" clamp-in valve	\$39.99

EZ-sensor®

Innovation by Schrader®

S57 Tool Features:

- Schrader's strong OE pedigree, EZ-sensor®, and its latest generation EZ-sensor® GO, provides users with 70% EV coverage for national brands. The OE quality sensors cover some of the most popular EV applications in North America, such as:
 - Tesla 3 (2017 – 2020)
 - Ford Mustang Mach-E (2021)
 - Tesla S (2014 – 2021)
 - Nissan Leaf (2011 – 2022)
 - Chevrolet Bolt (2017 – 2022) and more

Covers over 98% of TPMS equipped vehicles



CTPC- Commercial TPMS Profit Center

\$179.99

- Just what you need for any situation to get you through
- Valve stems for direct tire pressure monitoring systems
- Application: Commercial and Heavy-Duty Trucks (Class 5+) with OEM TPMS
- TPMS Type: M6 thread
- Kit includes the right mix of TPMS416, TPMS542, TPMS543E, TPMS5455, TPMS545D, TPMS545E, TPMS546G, TPMS553C, and TPMSV3202 along with a durable plastic case great for any service truck or bench.



Do you know what frequency TPMS that car requires?

Full Bulletin

Covers over 98% of TPMS equipped vehicles



SAJWJ6HL9GMK27927

S = 1995	2 = 2002	9 = 2009	G = 2016
T = 1996	3 = 2003	A = 2010	H = 2017
V = 1997	4 = 2004	B = 2011	J = 2018
W = 1998	5 = 2005	C = 2012	K = 2019
X = 1999	6 = 2006	D = 2013	L = 2020
Y = 2000	7 = 2007	E = 2014	M = 2021
1 = 2001	8 = 2008	F = 2015	N = 2022

Ask us about App controlled aftermarket TPMS, banded or valve mounted

Full Bulletin



McGee No.	Description	Price
46133560	Dual Band 315 & 433 Mhz EZ Sensor	\$29.99
46133561	Bulk 10 Pack EZ Sensor	\$249.99
46934000	Aluminum Stem for EZ Sensor	\$5.96
VS950	Rubber Stem for EZ Sensor	\$2.13
33700	High Speed EZ Sensor	\$34.99
21355	ST1 Tool with 28 EZ Sensors	\$699.00
21057	S57 Tool w/100 EZ Sensors	\$2,299.00

Designed to eliminate multiple sensors required for TPMS work

Angled Stems Available

APPLICATIONS:

Covers most GM, Chrysler, Honda, Nissan, Toyota, Lexus, Scion, Ford, Lincoln, & Mercury vehicles and some Mitsubishi, Subaru & Suzuki vehicles • Fully programmable • Compatible with Bartec, Schrader and SPX/OTC programming tools • Sensor features Wireless Auto Locate or WAL that allows the vehicle's TPMS system to locate and identify each TPMS sensor's specific location



Stem Base: VS15, VS950, VS950S VS20 VS30, VS90, VS45 VS1010 VS65* *VS925A & VS925C(silver), VS280SB & VS925B(black)

Ascot No.	McGee No.	Schrader Version	Description	Price
469-01030	1030K	SH20017AK	Siemens Kit for VW (Fits 1053 Sensor) (Orange)	\$3.76
469-01050	1050K	SH20013AK/ SH20030AK	Siemens Kit for Chrysler (White) SH20013AK includes bottom ball	\$3.48
469-01060	1060K	20001/20002/ 20135AK/20096AK	Fits Schrader SH20096 (Red)	\$1.88
469-01070	1070K	20004/20116AK/ 20115AK/20107AK	Fits Dill 9076, 9107, 9115, 9116 (Blue)	\$1.88
469-01080	1080K	20003/20007/ 20117AK/20028AK	Fits Dill 9028, 9034, 9064, 9081, 9117, 9161 (Green)	\$1.88
469-01090	1090K	-	Compatible with Beru Sensors (Grey)	\$3.75
469-20036		SH20036AK	Entire Valve (Schrader 20036) for Hyundai, Kia, Honda (Dill 1096)	\$10.22
469-01100	1100K	SH20032AK	Compatible with Pacific Sensors for Toyota/Lexus (Purple)	\$3.18
469-01110	1110K	SH20006AK	Compatible with Pacific Sensors for Toyota (Teal)	\$3.18
469-01130	1130K	SH20030AK	Compatible with Schrader 20005 (Burgandy)	\$3.41
469-20025	2000K	-	TRW Kit for Honda, Acura	\$3.95
469-20010	2010K	SH20015AK	Compatible with Schrader Sensors for Volvo (non-stock) (Lt. Brown)	\$1.92
469-20030	2030K	SH20016AK	Dill Sensors 9154, 9204, 9214	\$2.05
469-02040	2040K	SH20019AK	Kit for Honda Civic (Lt. Blue)	\$2.25
469-09250	VS925A	-	Aluminum Metal Replacement Valve for GM Snap-In	\$5.98
469-09251	VS925C	-	Chrome Metal Replacement Valve for GM and Ford Snap-In	\$4.76
469-00950	VS950	SH20018	Rubber Snap-In Replacement Valve for GM & Ford fits Schrader 46133500 (ea)	\$2.15
469-17208	VS950IV	VS950IV	Rubber Snap-in like VS950 for GM & Ford (Import)	\$.99
469-09305	VS950SC	-	Chrome Replacement Valve for GM and Ford Snap-In	\$2.63
469-34000	46934000		Alum Stem for Schrader 46133500 dual band	\$5.97
469-20020	-	SH20020	Replacement Stem Chrysler, Uses Kit 1050K	\$2.49
469-90660	9066K	-	Complete Replacement Stem Chrysler with Kit (9066B-Ball joint only)	\$4.84
469-07020	7020K	-	Accessory Kit for Redi Sensor	\$4.07
469-00770	VS70	-	Available on the following vehicle in various forms: Years 2010 to 2014 (Acura, Cadillac, Chrysler, Dodge, Honda, Hyundai, KIA, Mazda, Nissan) the sensor most associated with the VS-70 is 7001/HP or 7002.	\$8.87
469-00090	VS90	-	Key at base attaches via press clip; Fits Dodge Dart, Mitsubishi Mirage	\$5.98
469-17436	1743016	-	Smart Sensor Snap-In Valve for ITM, Cub, 31Inc, Pilot	\$3.34
469-20014	-	SH20014AK	Kit Fits EZ Sensor 34000 Stem	\$2.13
469-01010	VS1010	SH20018	Fits Hyundai Sante Fe Snap-In 7mm	\$2.62
469-00065	VS65	SH20635	Base of stem is square Snap-In Fits Doge Rams, Jeep Cherokee	\$4.26
469-17395	VS65IV	SH20017	Base of stem is square Snap-In Fits Doge Rams, Jeep Cherokee Import	\$2.44
469-00035	VS35	-	Dill TPMS clamp-in valve Dodge Ram (DA545D HighRail version)	\$8.14
469-00280	VS280SS		TPMS optional short stem clamp-in chrome (VS280BS-Black)	\$8.77
469-00919	VS919	-	Replacement TPMS stem for 19.5 Trk Wheels, parallel key	\$3.72
469-00241	VS241	-	2017 Ford F350 Super Duty dually aluminum	\$6.49
469-00200	VS20	SH20045	Rubber Valve Stem for 2015 and newer GM and Ford	\$2.88
469-20280	RV1000	-	Autel MX-Sensor Rubber press release stem	\$3.25
469-20279	MV1000	-	Autel MX-Sensor Metal press release stem	\$3.08
469-20281	CV001	-	Autel Black MX-Sensor Black Metal Valve	\$4.17
469-20282	CV002	-	Autel MX-Sensor Titanium Grey Metal Valve	\$4.17
469-20283	CV003	-	Autel MX-Sensor Chrome Valve	\$9.95
469-17393	VS920		.625" valve hole square found in Ford Super trucks/sprinters (VS919 Parallel key)	\$4.47
469-17398	1750398		Short Snap in good for custom applications parallel key	\$1.48
469-00490	VS490		Tesla OEM stem uses T20 screw, aftermarket wheel compatible OE Sensor available PN:2547	\$8.53
469-00015	VS15		Replacement Valve for Toyota Corolla	\$4.53
469-00312	VS312		Replacement Clamp in Stem for Toyota TPMS Adapter w/Bent 0.3 90"	\$6.40
469-00543	DA543E		Valve for GM	\$11.97
469-02045	2045K		TPMS Accessory Kit Honda Acura TPMS Valve Stem Assy Short TRW	\$2.61
	1096		Ball-seat valve stem assy w/ internal shear ring 43mm	\$8.60



Oil King

- Large 25 gallon capacity with sight gauge
- Convenient tool trays and filter areas
- Large offset collection pan with screen
- Oversized tires to get over hoses and rough floors



\$799.99
238866

Splatter pads available



Graco

AIR DIAPHRAGM PUMPS

3/4"	241906	15 GPM	\$695
1"	647731	40 GPM	\$945

McGee Company has Graco service and parts!

8-1 Drain Plug Wrench

\$18.33 - 31301219

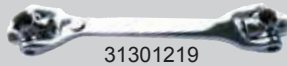

31301219

Balcrank

2140014- Evo Oil Hose Reel 50' x 1/2" ID Hose

\$545

2140008 Evo Air/Water Hose Reel 50' x 3/8" ID Hose **\$465**



- All Evolution series reels have a narrow and lightweight design; includes hose, hose stop and a 2.5' connecting hose.



Whip your shop into shape with stackable fluid storage & dispensing systems



Dual wall options available



225006 Fire-Ball® 300 Series 50:1

120 lb. (54 kg) Grease Pump Portable Package with Caster Base

\$1669

*109075 air regulator required and sold separately



Tank Gauges

Numbers decrease as fluid level lowers indicating how many inches are left until the tank is empty. For use with oil, waste, diesel fuel, antifreeze and other fluids with a high flash point.

008164 new oil gauge **\$249**



202577 Zinc Plated Steel Z-Swivel 1/4"-18 NPT **\$135**

224569 Zinc Plated Steel Z-Swivel 3/8"-18 NPT **\$165**



008566 used oil gauge **\$249**

Heavy Duty & High Quality



SDL25B 50' AIR **\$575**
SDM33B 35' OIL **\$629**
SDM65B 50' OIL **\$679**



EM8

25C903 — **\$479**
Rigid Extension
25C904 — **\$479**
Flexible Extension

- ELECTRONIC
- LIGHTWEIGHT

3330159 — Digital Meter **\$315**

- Low power consumption with auto sleep function
- .26-8 gal/min

Did you know we design complete systems for your needs?

It doesn't matter the size of your shop, we have the right solution for you. We can design at your location with tablets to give you an idea for a new system or an upgrade before we bring it back to design in CAD. Call today for your time and money saving system from the Graco pros at McGee Company.



1-800-525-8888

Graco Pumps & Accessories



24G576 LD Series 3:1 **\$565**

Affordable and full featured LD series is designed for lower volume applications.



246775 Fireball 225 3:1 **\$829**

Introducing Graco's classic Fire-Ball design as a 3:1



203876 Fireball 300 5:1 **\$1099**

This pump has been the "crown jewel" of Graco since the 1950s and is the pump of choice in the most demanding environments.

242056 1/4" Non Metered Grease Valve **\$195**

242058 3/8" Non Metered Grease Valve **\$229**

For heavy-duty applications, this non-metered dispense valve is designed to perform in heavy equipment shops, fleet maintenance shops, and municipal garages. Typical applications include service Heavy-duty dealerships, Fast lube centers, Automotive dealerships, In-plant, Lube trucks and Mining.

- Pressure-assisted trigger for ease of operation
- Easy top adjustment with locking nut
- Rugged design to withstand harsh environments



Bibb

\$12.99

- Durable, full volume dispense nozzle for water, windshield wash and antifreeze
- 1/4" NPT female inlet
- Max Operating pressure range of 30-35 lbs/in sq



180685

Lubrication Rebuild Kits



Pricing valid until 1/1/26



Quincy QT® Compressors "Rated #1"

Meticulously designed for maximum productivity. Completely rebuildable with stainless steel valves and heavy duty cast iron crank case and cylinders. Leading the industry with the most CFM per brake horse-power. Includes ASME receiver, enclosed belt guard, EPAct high efficiency motor, and loadless auto stop/start.

Part No.	HP	Electric Spec.	ACFM at 175 PSI	Tank Size	Price
2021116649	5.0	230V 1PH	15.2	60 Vert	\$1,965.85
2020040701	5.0	230V 1PH	17.2	80 Vert	\$3,156.00
2020040716	7.5	230V 1PH	23.6	80 Vert	\$3,299.00
2020040776	10.0	230V 3PH	36	120 Vert	\$5,710.00

3 Year No Bull Warranty

- 2 Year Full Package
- 3 Year Pump
- Recip Compressor Optional NO BULL Warranty 3-Year Pump / 2-Year Package Warranty



Please refer to instruction manual and warranty statement for recommended service intervals and requirements.

Proper Piping for Compressed Air

- 100% aluminum for compressed air, copper ok as well.
- 288 PSI rated
- Aluminum offers excellent mechanical resistance to pressure and to impacts.
- The upgraded design of the new PPS1 aluminum fitting is more compact, lighter and more resistant.
- The aluminum alloy used, combined with epoxy paint on the outside and a treatment on the inside, protects the pipe against the risks of oxidation and corrosion.
- Simply insert the pipe into the fitting and then tighten the PPS1 fitting.



2020014002 Service Truck Compressor Gas Honda 13HP 30 Gal Horiz - **\$3,450.00**

- Engine start on passenger side to keep technicians safe on the side of the road!
- Quincy QT-1 Splash Lubricated Reciprocating Air Compressor
- 13 HP, Honda Gas Engine
- 30-Gallon Horizontal
- 23.6 CFM @ Max PSI, 160-175 working PSI, Honda Gas-powered
- Cast iron pump w/aluminum head has 50,000 + Pump Life



Ask about our Energy Audits for rebates from energy companies

Lubricants

McGee Company stocks a variety of lubricants in various weights to fit your needs. Make sure you have the appropriate weight lubricant in your system to protect against high temperatures and frictional wear of bearings and cylinders that reduces the life of your compressor. McGee Company carries Quincy specific Quin-Cip/Quin-Syn through our house brand.



Part No.	Description	Price	Appl.
2024600602	10 weight gal.	\$65.40	Cold < 32°
2024600702	20 weight gal.	\$65.40	Warm < 68°
2024600802	30 weight gal.	\$65.40	Hot > 85°

4152051929 High Performance Series 101-10000

Quiet Rotary Screw Air Compressors

- 7.5 HP
- Quiet operation - lowest noise levels available
- 100% continuous duty operation
- Compact design in a complete package
- Simple and low cost maintenance
- Clean dry air
- Lower operating costs
- Proven design by a world leader in compressor technology
- 25.2 cfm @ 150 psi
- 208/230/460 - 3 ph
- 5 year warranty



Pictured with dryer



5HP to 15HP Available
208/230/460V
3PH

4152051929 \$9,356.57

Financing available through GreatAmerica or no payments till 2026 with NewLane!

ELIMINATE WATER!

Where Water Comes From

The atmospheric air entering a compressor intake contains water vapor. Because of the effects of compression, most of this water vapor turns into troublesome liquid water in your air lines.



RAD0025A1	25CFM 120V Refrigerated Dryer	\$1,729.00
RAD0055A1	55CFM 120V Refrigerated Dryer	\$1,928.00
RAD0075A1	55CFM 120V Refrigerated Dryer	\$2,667.00

Auto drain!

- Electric Operated Drain Valve 1/2"
- 1/4" NPT Inlet & 1/2" Female Pipe
- 300 Maximum Working Pressure
- 110 Volt w/6Ft Power Cord
- Y-Strainer & Ball Valve Included
- Adjustable Timer For Blow Down
 - » 1/2 Second - 45 Minutes Interval Time
 - » 1/2 Second - 10 Seconds Discharge Time

2523J - \$119.95



Call for quote on brake lathes

Featuring Pro-Cut or Hunter

Hunter ACE22

- 50% more power cuts rotors twice as fast as other lathes
- 12 seconds or less average compensation time
- Anti-Chatter Technology stops chatter before it starts
- Touchscreen interface provides easy controls and additional info
- Digi-Cal instantly measures rotor dimensions and depth of cut
- Adaptors designed to fit any vehicle
- Approved and recommended by multiple OEM partners



50-1347KIT - Procut International Adapters



50703 - Chip Deflector Silencer for Procut



Now! 06610 Round Bits

Faster turn!

- Round Carbide Bits for all Tool, Ammco, Hunter BL500 series, Performance and Rels lathes.



06610 - \$84.03

50742PRO - Procut OEM Bits 10Pk



- Use with 06700 holder. **\$164.29**

BITS — AMMCO, HUNTER, PRO-CUT, ACCUTURN

Drum & Rotor Silencers



5280

5290

6920

Silencers



6921

6922

6930AM

8500

7075

9183

9800

Ascot #	Part #	AMMCO Description	Price
416-05280	5280	Silencer Band - Drum 1-3/4"	\$68.00
416-05290	5290	Silencer Band - Drum 2-3/4" Truck Drums	\$93.86
416-06920	6920	Silencer Band - Ventilated Rotor	\$43.45
416-06921	6921	Silencer Band - Non-Vented Rotor 6.5" (Pkg 2)	\$17.53
416-06922	6922	Silencer Band - Non-Vented Rotor 9.250" (Pkg 2)	\$16.23
416-06930	6930AM	Silencer Band - Rotor - Heavy Duty. Ventilated	\$114.40
416-09183	9183	Replacement Pressure Pads - Non-Asbestos (Pkg 2)	\$28.26
416-09800	9800	Silencer Assembly - Spring - Vented - Rotor	\$61.82

Ascot No.	Part No.	Description	Sale Price
418-40410	940410	Carbide Insert, Pos. Rake, for FMC1 Lathes, 10pk.	\$88.56
418-40435	940435	Carbide Insert, Pos. Rake, for ACCUTURN5 Lathes, 10pk.	\$105.65
418-06914	691410	Carbide Insert, Negative Rake AMMCO lathes, 10pk., 1000, 2002, 3000, 4000, 4100, 7000, 7700	\$48.90
418-69186	69186	Carbide Insert, Positive Rake, AMMCO 3850 Lathe, 6pk.	\$71.46

Why pay for propellant?

Sure-Shot Sprayer

- Great way to dispense brake cleaner and other chemicals.
- To operate, load liquid and pressurize with air chuck. Easy!

M2400S
\$119.99



Ascot #	McGee #	Description	Price
632-01002	2000	1 Qt Rust Resistant Black Plated Brass Tank	\$74.99
	KM10	Repair Kit for 2000	\$34.95



MC GEE COMPANY
 offers turn key solutions for your shop or dealership equipment needs, lubrication systems, and compressed air including free CAD design!
Call today for pricing
1-800-525-8888



MORE INFO:

SPOA10-AV

- 10,000 lbs. capacity AV arms lift and service practically all roadgoing vehicles on ONE LIFT, including: • Battery Electric • Exotic Low Profile • Truck Frame • Unibody Cars & SUVs
- THE HIGHEST CAPACITY LOW-PROFILE LIFT AVAILABLE With the industry's lowest profile arm height available of any 10,000 lb. capacity two-post lift, technicians can easily spot lower profile vehicles without worry.
- THE LOWEST ADAPTER HEIGHT IN THE INDUSTRY The outer arm and adapter height are the same measurement reducing any possibility the arm makes contact with vehicle underbodies. The adjustable, low adapter height allows the needed reach to easily spot, lift and repair unibody, exotic and battery electric vehicles.
- Shockwave available



Financing available with no payments until 2026!

Our experts can help you design your air piping systems, lift installations, and lubrication systems to fit your needs.

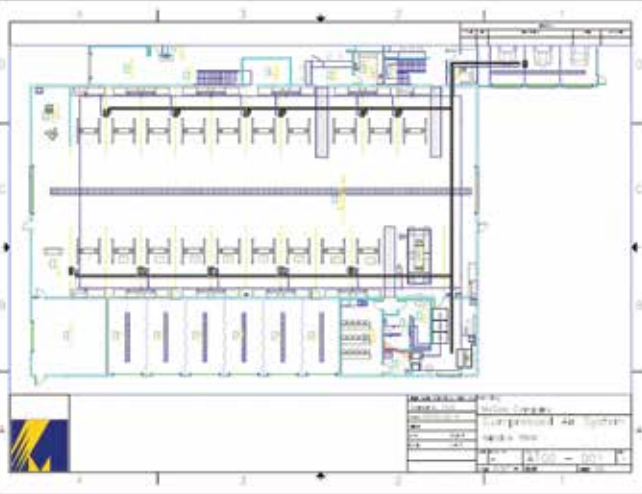

The World's Most Trusted Lift™ A DOVER COMPANY

Rotary Symmetric / Asymmetric

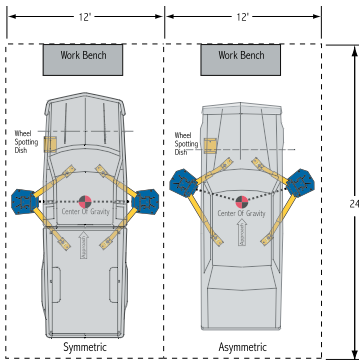

Benefits of True Asymmetric Lifting:

- When the lift is loaded properly, doors can be opened and the vehicle is positioned a minimum of 24" away from the nearest obstruction.
- With true asymmetrical lifting, the columns are rotated 30° to place the approximate center of gravity of the vehicle in line with the optimum load capability of the column, reducing unnecessary wear and tear on the column, carriage and bearings.
- Asymmetrical lifting provides more clearance at the rear of the columns (the open door contact point) approximately 117" vs. 103".

Versymmetric®* / 2-in-1 Lift

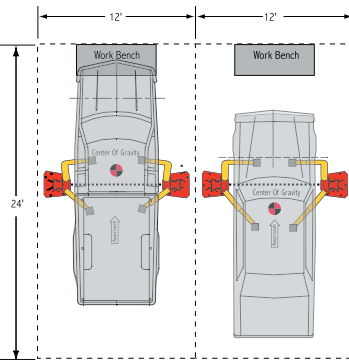

Pitfalls of Versymmetric / 2-in-1 Lifting:

- When the lift is loaded, long vehicles that should be loaded symmetrically extend too far forward, leaving no room for work benches or walking area. Asymmetrical lifting positions the vehicle too far back, which intrudes into the drive-through area or even an exterior bay door.
- Versymmetric lifting places the approximate center of gravity of the vehicle in front of or behind the optimum load capacity of the lift. By doing so, wear and tear on the column, carriage and bearings is increased.
- No spotting dish makes vehicle positioning "Guesswork".
- The front arm is offset 5" which requires short wheelbase vehicles be pulled further forward to clear the front tire, which reduces the clearance to open doors.



Versymmetric and 2-in-1 style lifts have short arms on the front and long arms on the rear. This is done to accommodate the pick up points of vehicles that are shifted to the rear in order to improve open door clearance for the technician getting in and out of the car. In a symmetric load condition the vehicle is centered fore and aft (not shifted to the rear). The short front arms are unable to reach the pick up points in the symmetric load condition. This can be easily demonstrated by picking up an F350 as shown.

LIF 814_V1_V01_2006.02
 ©2006 Rotary®. Printed in U.S.A. All Rights Reserved. Unless otherwise indicated, ROTARY, DOVER and all other trademarks are property of Dover Corporation and its affiliates.

* VERSYMMETRIC is a Registered Trademark of Challenger Lifts, Inc.

Mach Flex Mobile Column Lifts - Call for Demo!

- New higher column capacity 18,800 lbs
- Easy to use intuitive remote control operation
- Control all columns from anywhere in the bay with remote included with purchase.
- Includes LockLight™ on each column
- Vehicle Height and Weight digital display gauges



2, 4, 6, & 8 column configurations available!

SHOCKWAVE Equipped Lifts

- 2X Faster rise and descent than standard lifts
- DC powered which reduces installation/operating costs
- Two standard Group 24 batteries charged by the 110v that runs the lift removes the need for expensive 220v wiring and can operate during power loss
- Spotline motion activated laser helps spot vehicles the first time
- Available on lifts from 7,000-20,000 lbs



Inground Smartlifts

- 10,000-12,000 lbs capacity models available
- High efficiency power and air per lifting cycle, selected in key lead projects
- Reduces space usage and allows more lifts
- Trio three stage arms for pinpoint location
- Shockwave or standard available
- New wide inground (SL210W or SL212W) futureproofs your business, as they can service electrical vehicles.



SL210W



Wheel Arm for lifts 92100 - \$119.99



- 100 lbs Capacity
- Set of two arms
- Comes with 2 magnetic tool trays, hex key, and mounting shims



Wheel arms hold tires at the lift arm height – great for tire rotations and brake jobs

Norco 1/2 ton transmission Jack

- Fully adjustable universal saddle with adjustable corner brackets and safety chain, 72" raised height
- Safety overload system prevents jack from being used beyond rated capacity
- Foot operated pump and lowering pedals
- Two-stage flash chromed rams inhibit rust from entering hydraulic system
- Wide base with polyurethane wheels to protect floors.



72500E - \$1,399.99

AS3321 Ascot - \$1,199.99

Ask us about fuel tank saddles

Rubber lift pad for any lift available!



Ascot No.	Mfg. No.	Description	Application
309-00003	JOK03M	Rubber Lift Pad - 5" Round	Nussbaumlifts
309-00005	JOK05M	Rubber Lift Pad - 4" x 5"	BenPearsonlifts
309-00007	JOK07M	Rubber Lift Pad - 5" x 5"	Forward, Worth, American, Gemini, Grand, Tuxedo, Eagle, & Whip lifts
309-00009	JOK090	Rubber Lift Pad - 4" x 4"	Challenger CL9 and CL10 lifts
309-00022	JOK22D	Rubber Lift Pad - 3.25" x 4"	Rotary SPO10, SPO12 lifts
309-00014	JOK140	Rubber Lift Pad - 5.25" Round	Challenger CL10, Quality lifts
309-00011	JORB-1	Rubber Block 1.5"	Rotary Airjacks and all Mid-Rise pad lifts
309-00013	JORB-3	Rubber Block 3"	Rotary Airjacks and all Mid-Rise pad lifts
309-00006	JOK06M	Rubber Block 6.25"	Round Slip On ALM Lifts
309-00019	BH-7232-01U-4	Urethane for Challenger L10, CL12, E10, S10 & EV1020 - Set/4	



Each LOCKLIGHT™ includes:

- Indicator light assembly
- Pressure switch
- Mounting Bracket
- 10' of electrical wire

• Compatible with most surface and inground lifts using electric/hydraulic power units

- Retrofits to most existing lifts
- 110v and 220v configurations

Part #FA834/110v

Part #FA835/220v

CPH001 LED Rechargeable Headlamp - \$24.99

- Hands free on/off of main light
- ABS silicone band (lightweight)
- COB high, low, and flashing with 3W Led High/low spot
- USBC charging 3-4 hrs with working time 3-8hrs
- Waterproof and shockproof



Door Defender™

Rotary's new door defender allows technicians to easily enter and exit the vehicle without damaging their customer's vehicles. The door defender is a low profile solid rubber guard designed to fit over the two-post lift carriage. The N823 door defender kit includes: 1 door defender, adhesive to attach to the lift, a Rotary decal and instructions.

Model #N823



Norco under hoist stand 3/4 ton

- Lightweight, slender design makes handling easy, even in close quarters
- Quick adjust spin handle with thrust bearing eliminates wear and provides ease of turning under load
- Extended height 81"

81033A - \$219.99 | AS2811 Ascot Version - \$149.99

Lifting jack pads for Tesla models

TJP4 - \$24.99 or TJP4Y (Model Y)

- Set of four in convenient carrying case
- Protect the vehicle, battery and paint from damage
- Can be used with floor jack or 2-post lifts
- Top piece fits into designated factory lifting points



FJ6259KIT (Set of 4)

WANT TO KNOW WHAT OTHER EV FOCUSED PRODUCTS WE OFFER?



RA, TA, and Trio adapters for Rotary and other brands available, call for pricing!



AUTEL MAXISYS
ADAS
 ADVANCED DRIVER ASSISTANCE SYSTEM
CALIBRATION

Call today for ADAS training or information:
 1-800-525-8888!

Are you ready for ADAS?

McGee Company is at the forefront of ADAS sensor technology in vehicles. Let our qualified manufacturer trained sales representatives increase your profit margins with the right tools, training, and experience! McGee offers solutions from Hunter and Autel.



HUNTER
 Engineering Company

Ask about end user rebates!

525 WHEEL LIFT FOR DIRECT DRIVE BALANCERS

- 160 lb capacity, Air Operated
- Mounts to Direct Drive wheel balancers: 1300 1400 1500 1600
- Hi-Visibility floor ramp for easy roll on/off
- Smooth scissor-lift action
- Sliding work platform for easy operation
- Small footprint, low center of gravity for superior stability
- Simple foot-pedal operation



MAXX70 - Good!

- OE Passenger, Light Truck & SUV, Medium-Duty Truck
- Maxx 70 can tackle wheels from 6-24" in diameter and up to 16" wide – out of the box! Anything from standard passenger car tires to 6" lawn mower tires, all the way up to extreme 24" wheel assemblies.
- More Air + More Quickly = Jobs Done Faster
- Tool used to push the tire bead into the drop center, allowing for effortless mounting and dismounting of the tire.
- Our rock-solid 220V 2HP motor helps your shop keep up with ever-increasing customer demand.

*Max air motor HP dependent on shop air pressure



STEP UP

MAXX80 - Best!

- Wheel Handled - Alloy, Steel for Car & Light/Medium Truck
- Rim Diameter - 6-24"
- Max Tire Diameter - 50"
- Max Rim Width - 16"
- Bead Loosening Width - Up to 22" Wide
- Wheel Clamping System - 4 Clamps, Air Cylinder Operated
- Bead Seating Air Volume - 5.4 Gallons in Tower
- Air Drive System - Up to 4 HP*
- Electric Drive System - 220V 2 HP Electric, 110 Electric Motor
- 220V Electric Requirements - 220V, 10amps, 1PH, NEMA L6-20
- Footprint - 74"w x 86"h x 44" d
- Ship Weight - 850 lbs, Low Center of Gravity for Stability
- Warranty - 3 Years Parts, 6 Months Labor
- Part Numbers -

Electric 220V: 800MAXX80220 • Electric 110V: 800MAXX80 • Air: 800MAXX80A
 *Max air motor HP dependent on shop air pressure



1300

- Direct drive motor with 40mm shaft
- 2D Auto data entry
- 220V 1/3ph
- 8-30" diameter wheel range with max tire diameter of 44"
- Warranty: 3 Year Parts, 6 Months Labor



STEP UP

1500

- Direct Drive Motor
- Laser Guided Tape-A-Weight
- Side Shadow Board with Basic Pro Kit
- Auto Start Hood
- Static-On-Screen
- New Display Mounting Bracket
- Automatic Data Entry (Distance/Diameter/Width)
- 12 o'clock Inboard Laser
- Stop, Lock & Index



Tire Changer Duckhead Specials!

Hybrid Duckhead Mount/DEMOUNT Tool

85608959 **\$269.99**
Replacement tail
85608961
For 50X, 60X, 70X



Plastic Duckhead Kit

Part #AE183061 **Special \$26.99**



RP11811400325
Leverless Mount Head Insert Kit
TCX V3 **\$65.99**

RP11811100303S
Protector Plastic for Old TCX Steel Mount Head
\$1.78



Plastic Inserts for 182788 Metal Mount/DEMOUNT Head

(Pkg of 2) 50X, 60X, 70X
Model 182961

\$7.99



8560716108 - Grip Max Plus Grip Replacement 8/Set
2 inserts per jaw

\$89.99



Plastic Inserts for 182788 Metal Mount/DEMOUNT Head

(Pkg. of 12)
Model 182963
444-82963

\$26.97



Coats Leverless DuckHead®

Coats Leverless DuckHead® hook and tail booties provide the proper rim protection for all leverless DuckHead® systems - Proguard

89233409 6 hooks, 2 tails **\$169.99**



Pictured: PN 89233409

Head, Mount/DEMOUNT, Polymer Red

Hunter TC3250/3500
(1 ea.) Part #2216752



\$22.99 ea.

Hunter TC500 Series

Part #RP118314813



\$32.99 ea.

Grey Plastic High Spoke Mount/DEMOUNT Duckhead® Tool

For Coats 50X and 70X machines
Part #184432



\$34.99

Hunter TCX Series "Wing" Duckhead

RP11811400327



\$26.99

183606 Coats Sock Bead Loosener Shoe 2/PKG



\$49.99

85607787 Grip Max Plus Laminated Clamps (4) 6"-24"

\$129.99



435685 - Drop Center Tool for Bead Depressing

\$34.99



RP6710014120 Toolhead Wide TCA34 Butler Black

For use on TCA34 w/Serial number 664 and above
\$27.99



44422019 - Long Sock for Bead Lifting Tool

4 Pack - **\$21.99**
• High quality plastic sleeve prevents the rims from scratching while lifting the bead
• Made from high quality, durable nylon
• Ribbed design for anti-slip contact



5500 Low Profile Bead Lever Tool

Designed by technicians to assist with hard to change low profile tires. The easy grip ergonomically designed handle allows the user needed leverage for the toughest of sidewalls while remaining a safe distance from the face of the wheel.



Now \$49.95

For All Rim Clamp Tire Changers

Part # 181354 **\$34.99**
444-81354



AS23614 23.6" Bead Lifting Tool w/HD Grip

• Enhanced angle that allows a more efficient grip of the tire without letting it escape
• Made from hardened steel and is nylon-clad with a permanent hard-wearing nylon cladding to protect and preserve wheel surfaces during tire mounting



444-23614 **\$64.99**

For Coats 50X and 70X
Part # 182788



\$124.99

High Grip Jaw Protectors

Polymer jaw covers prevent metal-to-metal contact when performing external clamping. - TCX500 Series Machine

RP11811100358 - 8 ea. **\$129.99**



Plastic Handled Brass Sidewall Brush

• Densely packed brass bristles
• Great for cleaning white sidewall tires



99593

Wooden Handled Wire Brush with Metal Scraper



Ascot No.	McGee No.	Description	Price
395-13124	99593	8" Plastic Handled Brass Sidewall Brush	\$9.49
535-00150	25150	14" Wooden Handled Wire Brush	\$3.69

75B Racket for 75 Mounting Paste \$19.99

and 75NB (low profile)
Made in Taiwan · HD steel
Mounts to TC and includes hardware



Slide Cover for Bead Lifting Tool

Protects custom rims.

85000783 - Slide Cover for Top of Bead Coats Lifting Tool - 10 pk - Coats **\$79.99**

RP11811400098 - 4 pk for Hunter tire machines ever sleeve protector - Hunter **\$48.99**



85000783

Tire Changer Cabinet

719-82222
Storage cabinet for Rim Clamp Tire Changers



14x23x8.5"

Coats Replacement Tire Changer Air Hose - 5 ft. x 1/4"

Coats Replacement Tire Changer Air Hose with Euro Chuck

Part # W44RJ5 **\$13.49**

12786872 - Hunter 5' x 1/4" **\$16.99**



USA MADE

COATS

85610104 ADJUSTABLE PIN PLATES SET OF 3 FOR LUGS 3,4,& 5 \$3,299.99

- Works on any 40 mm balancer
- Adjustable design provides fast and easy clamping
- Lug clamping and centering prevents damage to alloy wheels
- 85609688-5 lug, 85609689-4 lug, 85609690-3 lug



85607503 - Slide Nut Premium 2 Jaw 40mm \$449.97

- Solid metal body lasts longer and won't shatter, if dropped.
- Binary Thread Engagement stays fully open during installation, eliminating wear from dragging the teeth across the balancer's threaded shaft.
- Fits coats 40mm shafts
- 85608312- No mar ring & 8112106 Pressure cup



8111935 - Spacer Lt Trk Back Cone \$399.99

- For use on certain deep offset applications.
- Can be used on any 40mm wheel balancer.



Steel ProGrip Quick Nut with Handles and Pressure Cup



483-40806

HW124408006 - \$299.99

Cemb 41FF83148 - \$459.97

Quick release wingnut with reverse mounting cup & no-mar ring, not for use with HD Truck balancers

Creates pressure necessary for Road Force balancers.

HUNTER, COATS

All Hunter Models exc 700 and DSP9500 90-92; All Coats Models Quick Nut Only

Coats Models 700, 775, 800, 825, 850, 875, 925, 950, 1000, 1025, 1030, 1035, 1175, 1250, 1255 (40mm shaft upgrade), 6275HS

Rubber Rings for quick releases

1061572 - 6" Rubber ring for Hunter quick release nut \$15.99

Fits all Hunter balancers

Prevents marring of the wheel during wheel balancing service when using a pressure cup
For use with steel wing nuts and quick release

Made in Taiwan

106822 - 4.5" Rubber ring quick release nut \$14.49

Made in Taiwan

Prevents marring of the wheel during wheel balancing



\$829.99



483-40110
(HW150400110)
ProCollet Kit 40mm

9 pc.
2.07" to 4.76"

The Low-Taper Collets are superior to standard cones because they have more contact area and engage the wheel at a better angle; they are also necessary for Clad Wheels because they are shorter and only contact the metal part of the wheel. They can be used for "standard" wheels as a replacement for the cones.

In Stock — Call for best price!

HUNTER

2027651 - Bullseye Collet Kit Gen \$1,198.99

Kit includes:

- A. 175-392-1 6 in. clamping cup
- B. 46-653-2 Performance wheel & light truck spacer
- C. 14-1470-005 Cone carrier bracket support
- D. 56-70-2 Front balancer cone carrier
- E. 20-2683-1 Passenger to 3/4 ton dual-taper collet kit
- F. 106-157-2 Protector sleeve



2033581 - Collet Kit Economy MD \$1,299.97

- Does not handle the large 8 lug/8.7" bore found on some medium duty trucks. 20-3155-1 covers that application and includes 20-3116-1. Includes application chart.



2036981 - Flange Plate and Stud Kit Adjustable \$1,399.00

- This durable aluminum design can adjust from 98 to 210mm bolt patterns and covers almost all wheels in this range. It comes with (3) three sets of (5) five pins each to handle any application. These pins are 2, 2.5 and 3.25" long with diameters of 1 to .75" respectively.



6763 - PCD Wheel Bolt Measuring Tool - \$12.99

- Can be used to measure a wheel or turned over to measure studs on a vehicle
- This wheel rim bolt pattern gauge is made of the best quality plastic material
- Lightweight and durable
- Quickly measures most common 4, 5, 6, 8 lug bolt patterns, it shows both inch and metric sizes.



Light Truck Cone Kit

HW150280091 28mm \$319.99

Allows balancing truck wheels with center holes from 4^{13/16}" to 6^{7/8}".

Used on rims with an alignment pin on the back. Double-sided cone fits all Coats balancers

40mm - 48340091 (113277) \$299.99

\$39.99



Model #61123 Balancer Calipers
482-89011

Works on any passenger balancer. Equal to Coats 61123 or 309011 or Cemb 46FC77653

\$319.97



Part #85009998 08 40mm I.D. - Shaft, Hubnuts, & Press Drum

Nut-Slide, 2 Jaw, 40mm w/drum, for use on 700-1250 Coats models or Cemb with 40mm shaft
28mm version 85009996

\$239.96



Model #112103
40mm I.D. - Shaft, Hubnuts, & Press Drum
Hub Nut, Handle, Solid, 45mm for standard thread pitch (not for XR-Series)

\$269.99



8500920401 Balancer Shaft 40mm Balancer Shaft for 850, 950, 1050, 1055, 1250, XR, & 1150 Models

McGee Power Scrub

MPS 2.5L Ind Hand Cleaner.
This heavy duty, solvent free, walnut shell based cleaner does it all. It cleans the toughest soils, greases, inks, paints, and almost anything else. Fortified with a new generation emollient package that leaves your hands feeling great. The concentrated one soap that does it all.

Purchase a case of four and get a FREE* dispenser

*Valid for first case **\$99.96** purchase



Super Tough Hand Scrub

395-00640 TS64 64 oz. tub
\$17.99

- Leaves hands soft and chap free.
- Removes dirt and grease quickly.

Now! Tuff Scrub Cleaner in a liquid TS1GAL (NP No Pump available)

Easy to use pump style - **\$27.99**



MNB-McGee Nail Brush \$4.95

- Double sided brush effectively removes dirt, grease, and oil from hands and beneath fingernails
- Designed with a comfortable, ergonomic handle, the brush features bristles that are sturdy enough to tackle stubborn grime without harming the skin
- The opposite side of the brush includes finer bristles, perfect for cleaning under fingernails.



Only \$24.99 ea



MPS wall dispenser DSP1JT25

"The best hand cleaner available"

25103 - Universal Absorbent Drum-top Pad - Pads 20/bx **\$49.99**

26201- PIG WTR RPL OIL ABS MAT WHITE 50 X15 LT-WT RL **\$29.99**

25201 - PIG UNV LT WT ABS MAT GREY 50 X15 RL **\$28.99**



Use With:	55-Gallon Steel Drum
Color:	Gray
Dimensions:	ext. dia. 22"
Mat Weight:	Light-weight
Fluids Absorbed:	Oils, Coolants, Solvents & Water
Recycled Content:	25% or more Recycled Content
Absorbency:	Up to 3 gal. per box
Absorbency per:	Up to 18 oz. per pad
Dispenser:	Yes
Poly-Backing:	No
Pre-cut Holes:	1 (.75" Dia.), 1 (2" Dia.)
Sold as:	20 pads per box
Weight:	3 lbs.
Composition:	100% polypropylene

FREE magnetic dispenser w/purchase of three rolls while supplies last!

FGGPCR75 - Trash Can Liners HD Blk 55Gal 10/RL & 10RL/Bx **\$52.99**

- Made with up to 70% post-consumer recycled plastic
- 3-ply strength means no tears or leaks
- 1.25 mil, 100 bags per box
- Extra heavy duty, black bags
- Coreless rolls with perforation for easy opening



Tire Bags, Seat Protectors, Steering Wheel Covers, Paper Floor Mats, Parts Bags



#SWC 500 ea



#PSC



#DR



#WPB



250 Bags! - HDTB



#FPFM

Dispensing Racks

Centralize your cleanliness products for the professional image your business needs and the convenience your employees deserve. The top tray holds paper floor mats and elastic band steering wheel covers. Rollers are for seat covers, tire bags, and parts bags.

Order No.	Description	Ship Wt. Lbs.
PSC	Seat Protectors - Roll of 500	20
SWC	Car Steering Wheel Covers - 500 pkg	10
HDTB	Large Tire Bag for SUV - Roll of 250	30
FPFM	Heavy Duty Paper Floor Mat - Box of 500	32
WPB	Parts Bags, 12" x 20" - Roll of 500	15
DR	Dispenser Stand Only	25
41110	Large Tire Bag - Roll of 100	13

Static Cling Printer

Full feature Reminder Sticker Solution takes professionalism to a new level

- Godex Printer pre-programmed to work out of the box
- 1 year parts and labor warranty (6 months on print head)
- Includes 1 ribbon



399-11111

Static Cling Reminder Stickers \$29.99

- Excellent item to promote repeat business
- Keeps your name, the service to be done and the time to do it in constant view of the customer
- More effective than a door jam sticker
- Static cling vinyl will cling to almost any smooth surface
- No adhesive residue and they can be removed for cleaning and replacing
- Silk screen printing process for a high quality image and a writing strip that won't allow the ink to fade
- Generic design stickers as well as personalized stickers
- RL/500



ORS



Chain Laws:



- ⊕ **Less weight than chains**
- ⊕ **No damage to vehicle**
- ⊕ **No climbing under vehicles to grab broken chains**
- ⊕ **Great for low wheel clearance vehicles**
- ⊕ **Faster to put on, less than 5 minutes!**

Showroom displays for the floor or counter available!

DISTRIBUTORS WANTED



A specially designed surface pattern that makes the total contact area exposed to dry friction as large as possible.

AutoSock® gets fuzzy “hairs” between and at the contact areas in order to increase the friction on snow and ice.

Mesh keeps snow out of the tread and wheel well while the orange straps help with centering and easy removal.

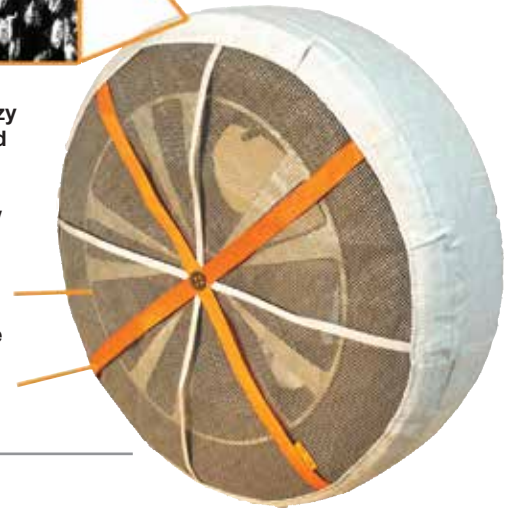

Safety tear-way Vest HI_VIZ

- Tricot polyester interlock
- CSA Z96-22 Class 2 Level 2
- ANSI/ISEA 107-2020 Class 2 Type P and R
- StarTech® reflective tape
- ID pocket
- 5-point tear-away
- 4 sealed pockets
- Radiophone clip strap
- D ring access slot



SVOLXL - Orange
SVYIXL - Yellow **\$14.99**

Hwy Warning Triangle & Storage Case

- Set of 3 includes carrying case
- High visibility during daytime and night-time
- Reinforced cross base
- Large 17" x 17" triangle

1014509
\$45.99



AS876404 - Heavy Duty Pry Bar 4 pc **\$34.99**

- Meets or exceeds the standards established by the American National Standards Institute
- Contents: 1/4" x 8", 3/8" x 12", 7/16" x 18" & 7/16" x 24" pry bars in handy storage tray
- Chrome vanadium steel shafts for high strength and durability while having anti-corrosive properties
- Injection molded handles



Counteract

Balancing the wheels of transportation

8 oz Grease Tubes

- Our formula helps eliminate greasy messes on chassis and air hoses
- Minimizes steer tire wear
- Minimize premature wear on front end vehicle components
- Verified for use in all 4 seasons



\$12.99 ea.

Ascot No.	Mfg. No.	Description
451-50008	CBB-5WG8oz	8 oz. Grease Tubes

2 oz Grease Packets

- Lasts twice as long as competing grease products
- Water-resistant
- Contains rust and corrosion inhibitors
- Two, easy to use applications
- Eliminates friction and premature wear on trailer attachments



\$2.99/packet or \$114.99/case of 48

Ascot No.	Mfg. No.	Description
451-50002	CBB-5WG2oz	2 oz. Grease Packets

AutoSock has the OE Approvals!



AutoSock is mentioned by name in the above OE manuals.

AutoSock is approved by leading international car manufacturers.



Why sell or use **AutoSock**?

- ⊕ OE trusted & approved by name
- ⊕ The original ATD pioneered by textile scientists
- ⊕ Fewer SKUs than the competition with better coverage with 300 more tire sizes!
*Comparison as of 6/15/23
- ⊕ Faster/easier to put on than chains
- ⊕ Multilayered design for durability & wear indications
- ⊕ Approval all the way through six axel vehicles throughout the US

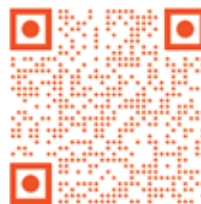

www.AutoSock.us



Not all Traction Devices are Created Equal!

	AutoSock	Competition
Made In	India	China
Passenger Number of SKUs	10	16
Meets EU Winter Traction Standard	Yes	No
3rd Party Testing	Yes	No
Wear Indicators	Black innerlayer showing	Tearing
Max Speed	30 mph	25 mph
OE Approvals**	Yes***	No
Side Webbing	Yes	No
Designed to Fal Away From Vehicle	Yes	No
Durability	Two Layers	One Layer
Truck Approval up to 6 Axel & Below	Yes	No



*Comparison data 6/15/2023

**19 OEs as of 6/15/23 with AutoSock mentioned by name. Most up to date info at www.AutoSock.us

***Only DOT approved ATD product up to six axel vehicles in WA

TIRE CHAINS



Laclede™ Wide Base Truck Chains

Tire Sizes			Non-Cam Stock No.	Cam Stock No.
8.25-15LT	275/70R16LT	235/75R17.5	3210R	3210CAM
10-15LT	285/65R16	245/70R17.5		
265/70R15LT	295/50R16LT	245/75R17.5		
265/75R15LT	235/80R17	255/65R18		
305/50R15	245/75R17LT	P255/70R18		
31X10.50-15LT	255/60R17	P265/65R18		
33X10.50-15	P255/70R17	255/70R18		
P265/70R16	P265/65R17	275/55R18		
P265/75R16	P265/70R17	265/50R19		
245/85R16LT	265/60R17	275/55R19		
265/70R16LT	265/70R17LT	225/70R19.5		
265/75R16LT	265/75R17	245/60R20		
265/80R16LT	275/65R17	265/60R20		
PR78-15	275/65R16LT	305/45R17	3227R	3227CAM
11-15LT	285/60R16LT	P265/60R18		
31X11.50-15LT	32X11.50-16LT	285/60R18		
32X11.50-15LT	33X13.50-16	285/65R18LT		
33X9.50-15LT	34X9-16	285/45R19		
33X13.50-15	12-16.5LT	275/60R20		
34X9.50-15LT	31X10.50-16.5LT	P285/50R20		
PR78-16	285/60R17			
P285/60R16	285/70R17			
275/75R16	265/70R18	275/50R20	3228R	3228CAM
285/75R16LT	P275/60R18	275/45R21		
31X12.50-16	275/65R18			
12-15LT	35X12.5-16	295/70R18LT	3229R	3229CAM
P315/70R15	35X13.5-16	325/60R18		
325/60R15	36X13-16	33X12.5-18		
31X13.5-15	32X12.50-16.5LT	33X13-18		
32X12.50-15	33X12.5-16.5	275/65R20LT		
33X12.50R15	33X15.5-16.5	285/55R20LT		
33X14-15	275/70R17	285/60R20		
33X14.50-15	285/75R17LT	295/55R20		
35X12.50-15	295/70R17LT	305/50R20		
35X14.5-15	305/65R17	305/55R20		
11L16	305/70R17	32X11.50-20		
285/70R16LT	33X12.50-17	33X12.5-20		
295/75R16LT	10.50/80R18	285/50R22		
305/70R16LT	275/70R18LT	33X11.5-22		
305/85R16LT	285/75R18LT			
QR78-15	315/70R17LT	35X12.5-18	3231R	3231CAM
35X13.5-15	325/70R17	285/65R20		
37X13-15	345/55R17	295/65R20		
315/75R16LT	35X12.50-17	325/60R20		
345/55R16LT	37X12.50-17	35X12.50-20		
37X12.50-16	305/60R18	325/50R22LT		
38X13-16	305/70R18LT	35X12.5-22		
38X12.50-16.5	325/65R18	295/60R22.5		

Tractor Chains

Tire Sizes					Stock No.
9.5-24	9.5-28	11.2-24			DUO214
9.5-32	11.2-28	230/95R32	355/80R20		DUO226
10.5/80-18	12-16.5	280/70R20	300/70R20	315/75D15	DUO225
12.4-24					DUO229
9.5-36	9.5-38	11.2-32	12.4-28		DUO218
13.9-36	320/85R34				DUO242
13.6-24	13.6-26	14.9-24			DUO240
14.9-26					DUO250
14.9-28	14.9-30				DUO252
13.6-28	16.9-24	320/85R38	340/85R28	380/85R34	DUO260
14.9-38	15.5-38	320/90R46			DUO254
17.5-24	17.5L-24				DUO263
16.9-26	16.9-28	420/85R28			DUO262
18.4-16.1	21.5L-16.1				DUO264
18.4-24	19.5L-24				DUO268
16.9-30	18.4-26	18.4-28	18.4-30	540/65R30	DUO271
550/65R25	600/65R28				
18.4-34	480/85R34	600/65R25			DUO273
16.9-38	18.4-38	20.8-34	420/80R46	460/85R34	DUO272
480/80R38					
18.4-42	18.4-46	380/90R54	480/80R46		DUO277
20.8-38					DUO276
24.5-32	23.1-34	28.1-34	620/70R42	650/75R32	DUO282



Laclede Snow Blower & Garden Tractor Chains

Tire Sizes		Stock No.
4.00/4.80 x 8		1301G
16 x 6.50 x 8	15 x 6.00 x 6	3300G
18 x 8.50 x 8		3307G
20 x 10 x 8	20 x 10 x 10	7145G
20 x 8.00 x 10	20 x 8 x 8	1308G
23 x 9.50 x 12	23 x 10.50 x 12	5307G

Other sizes available - call for details.

Laclede Forklift Chains

Square link alloy cross chains

Tire Sizes				Stock No.
6.50-10				2108FL
7.50-10	7.00-12	25 x 8.50-14		2110FL
7.00 x 15	28 x 9-15	29 x 8-15	8.15-15	2116FL
27 x 8.50-15	28 x 9.50-15			
7.50-15				2121FL
250-15	27 x 10.50-15			2129FL
8.25-15				2128FL
300-15	28 x 12.50-15			3129FL

Laclede ATV/UTV Chains

- Reinforced cross chain for increased wear and traction
- Two link spacing cross chain

Tire Sizes					Stock No.
24 x 9 x 11	24 x 11 x 11	25 x 10 x 11	25 x 11 x 12	26 x 10 x 12	618
24 x 11 x 9	24 x 11 x 12	25 x 10 x 12	26 x 9 x 12	26 x 10 x 14	
24 x 11 x 10	25 x 8 x 12	25 x 11 x 9	26 x 9 x 14		

Tire Chain Adjusters



Passenger Car
No. 29110
Trucks Nos 29925 & 29229



Truck
No. 6032



Grader
No. 6304



Truck
No. 0218



Passenger Car
No. 39110
Trucks Nos 39925 & 39229

Online Size Lookup



LG Cam Series Available



Grader Chains

Tire Sizes			Tire Chain Stock No.
13.00-24/25	14.00-20/21	15.5-25	2612
14.00-24	14.00-25	400/75R28	2615
16.00-20/21	17.5-25		2624
16.00-24	16.00-25		2627
20.5-25			2633
18.00-25	18.00-24	18.00-26	2636
23.5-25			2645
26.5-25	755/70R25	30.5R32	2657
710/70R38		800/65R32	

Laclede Single Truck Chains

Recommended for highway use • Available in R — regular side chain • Available with cam side chain

Tire Sizes				Non-Cam Stock No.	Cam Stock No.	Weight Per Pair	Cross Chains Per 1/2 Pair	Replacement Cross Chain	
10-15TR	11R17.5	9-22.5	275/70R22.5	N/A	2239CAM	44	13	6251	
QR78-16	8.25-20	245/75R22.5							
9.00-20	10-22.5	255/80R22.5	265/75R22.5	2241R	2241CAM	46	14	6251	
10.00-20	11-22.5	275/80R22.5		2245R	2245CAM	49	15	6251	
285/75R22.5	295/75R22.5	305/70R22.5	275/80R24.5	285/75R24.5	2247R	2247CAM	48	14	6253
10.00-22	11-24.5			2249R	2249CAM	53	15	6253	
11.00-15TR	11.00-20	12-22.5	12.5-22.5	295/80R22.5	2251R	2251CAM	62	14	6260
12.00-20	13/80R20	11.00-22	315/80R22.5	12-24.5	2255R	2255CAM	67	14	6263



Ascot No.	Mfg. No.	Description	Qty.
458-29110	29110	Passenger Car - Rubber	2 per bag
458-29225	29225	Light Truck - Rubber	2 per bag
458-29229	29229	Heavy Truck - Rubber	2 per bag
	0218	Spider Truck	2 per bag
458-06302	6302	Light Truck - Spring	1 pair per container
458-06304	6304	Tractor/Grader - Spring	1 pair per container
	39110	Passenger Car - Rubber Arm Blue	2 per bag
	39225	Light Truck - Rubber Arm Grey	2 per bag
	39229	Heavy Truck - Rubber Arm Green	2 per bag

Why studded tires are the best choice for winter driving!

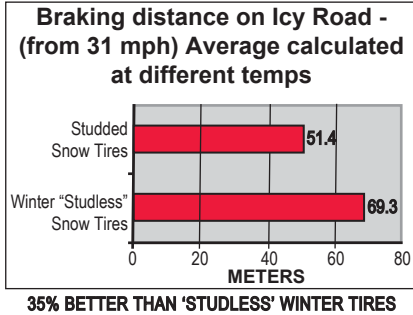

35% BETTER THAN 'STUDLESS' WINTER TIRES

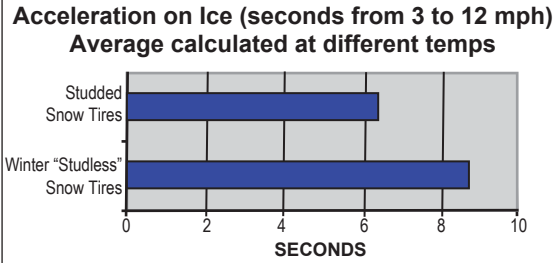

STUDDED TIRES 36% BETTER THAN WINTER 'STUDLESS' SNOW TIRES

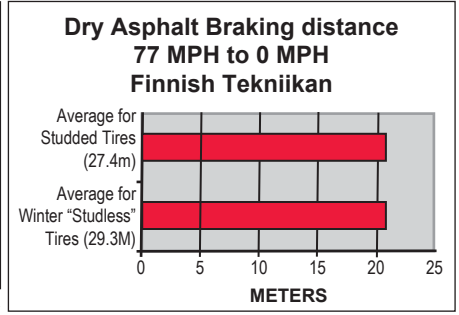

Stud Gun, Studding Equipment

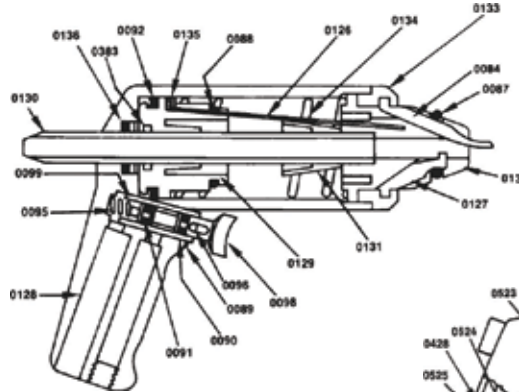

Parts Breakdown



ASCOT NO.	MFG. NO.	DESCRIPTION
458-00010	10G	Stud Gun. Standard of the Industry. Automatic. Light weight.
458-00002	KFP2	Stud Feeder. Fully automatic with 110 Volt motor, fast loading. Provides positive stud orientation. Feeds up to 225 studs per minute.
458-04048	4048	Feederboy Stud Gun. Designed for fast feeding studs of the AS-9 Gun. Attaches with screw clamp. Operates by manually turning the feeder cap.
458-00005	K5	Stud Stand. Saddle, extension for feeder & tray. Welded steel construction. K5M doesn't have tall post.
458-00500	K500	Studding Equipment Kit. INCLUDES: K-5 stand, AS-9 gun, KFP2 automatic stud feeder.

STUD GUN PARTS (AS-9 MODEL)

Part No.	Description
0084	External Finger
0087	O-Ring
0088	O-Ring
0089	O-Ring
0090	O-Ring
0091	O-Ring
0092	Piston Cup
0095	Trigger Spring
0096	Trigger Pin
0098	Trigger
0099	Trigger Sleeve
0126	Pressing Spring
0127	Internal Finger
0128	Handle Body
0129	Piston
0130	Feed Tube
0131	Tapered Sleeve
0132	Head (Steel)
0133	Ring Nut
0134	Compression Spring
0135	Ring
0136	O-Ring
0383	Piston Cup

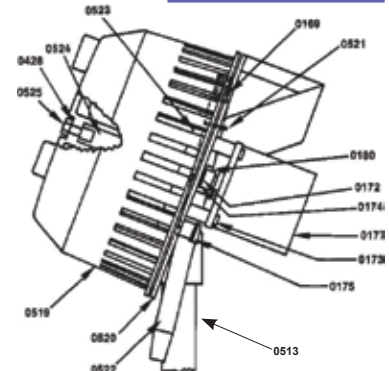

STUD FEEDER PARTS (KFP2 MODEL)

Part No.	Description
0169	Deflector Spring
0172	Snap Ring
0173	Screw
0174	Washer
0175	Clamp
0177	Motor
0180	Drive Shaft Pin
0428	Washer
0513	Clear Tube
0519	Feed Wheel
0520	Base Plate
0521	Retaining Ring
0522	Feed Tube
0523	Screw
0524	Shaft
0525	Hex Bolt

Ugigrip®, Self-Adjusting Carbide Tire Stud

- Delivers full-time traction, increases the safety, convenience and security.
- To order studs to best fit your customers' tire, use the TSMI number recommended by the tire manufacturer



SINGLE FLANGE STUDS:

TSMI Size	11	12	13	15	16	17	19
Overall Length	.345"	.375"	.470"	.520"	.585"	.615"	.635"
Jacket Dia.	.197"	.197"	.197"	.197"	.197"	.197"	.250"
Bottom Dia	.354"	.354"	.354"	.354"	.354"	.354"	.435"
Nearest 32" to Hole Depth	11/32"	12/32"	13/32"	15/32"	16/32"	17/32"	19/32"

Stud Gun Repair & Conversion Kits

ASCOT NO.	GUN	USE WITH STUDS NUMBERED
458-03810	0381	Tire Stud Mini Repair Kit. INCLUDES: (3) 0084 External Fingers; (1) 0087 O-ring; (1) 0088 O-ring; (3) 0126 Pressing Springs
458-03820	0382	Tire Stud Gun Large Repair Kit. INCLUDES: (6) 0126 Pressing Springs; (3) 0084 External Fingers; (2) 0087 O-ring; (2) 0088 O-ring; (1) 0092 Piston Cup; (1) 0136 O-ring
458-00911	0911	AS-9 to AS-11 Conversion Kit. Converts AS-9 Gun to AS-11 Truck model. Includes (1) 0401 Truck Feded Tube, (1) 0400 Truck Stud Gun Head, (3) 0127 Truck Stud Gun Internal Fingers



McGee Company
1140 South Jason Street
Denver CO 80223

PRSR STD
 U.S. POSTAGE
PAID
 DENVER, CO
 PERMIT NO 1772

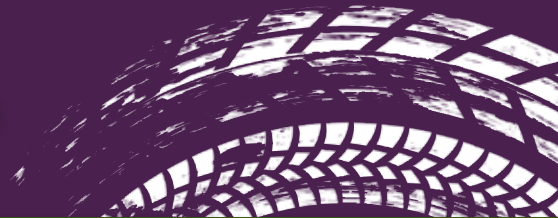

ATTN: ROUTE TO SERVICE DEPARTMENT

©2025 McGee Company, Denver, Colorado

McGeeCompany.com • 1-800-525-8888

Truck Service Gauges



- Wide variety of service gauges to accommodate the numerous tire and wheel configurations encountered by tire service personnel
- Available in chrome plated or protective black epoxy finish as indicated
- Calibrated from 10-150 psi in 2 pound increments
- Nylon or metal indicator bars

Ascot No.	McGee No.	Gauge Type	Price
476-10135	GA135	Angle Chuck With Nylon Bar	\$9.37
476-11135	GA135S	Same As Above, Angle Chuck With Metal Bar	\$12.28
476-10155	GA155	Straight-On With 30° Reverse Chuck	\$16.99
476-10165	GA165	Same As Above, Straight-On With 30° Reverse Chuck, Black Epoxy Finish	\$11.70
476-11155	GA155S	Same As Above, Straight-On With 30° Reverse Chuck, Metal Bar	\$20.53
476-10185	GA185	Dual Foot Service Gauge With Nylon Bar, 180° Chuck, Chrome Plated	\$11.42
476-01046	7285E	Externally Adjustable Metal Bar Truck Gauge – 10-150 psi	\$16.87

47101 - Repair Kit PSGR Tire Start Up Built On Demand \$429.99

- Tool box style for mobile tire repair
- Everything you need to get started, patches, cements and tools

See what's inside by following this QR



Tire Swabs and Brush



Now! \$2.19 ea. 000491

Ascot No.	McGee No.	Description
437-00001	000491	Tire Swab - 11" OAL X 2" Diameter
437-00002	TS2	Tire Swab - 15" OAL X 2" Diameter
437-00003	TS3	Tire Swab - 18" OAL X 3" Diameter
437-40006	73	Tire Lubricating Brush

Outfit Your Workspace

- 1750 lb. capacity HD steel construction
- Equipped with easy-to-use leveling feet
- Bolts together for quick assembly
- Sliding storage drawer
- Blue powder coated finish
- Dimensions: 63"x27"x34", 124Lbs

\$449.99

NEW



72163001 Work Bench

15 Pc. SAE Long Combination Open End Wrench Set \$129.99

- Open-end grip provides 25% more torque
- Offset box end
- Comfortable I-beam handle design
- Chrome plated for rust protection
- Made in Taiwan
- **AS9415**- Fractional sizes: 1/4", 9/32", 5/16", 7/8", 11/32", 3/8", 7/16", 1/2", 9/16", 5/8", 11/16", 3/4", 13/16", 15/16", 1"
- **AS9515** Metric sizes: 8mm, 9mm, 10mm, 11mm, 12mm, 13mm, 14mm, 15mm, 16mm, 17mm, 18mm, 19mm, 20mm, 21mm, 22mm **\$129.99**
- **11 Piece AS9511** Metric sizes: 8mm, 10mm, 11mm, 12mm, 13mm, 14mm, 15mm, 16mm, 17mm, 18mm, 19mm **\$99.95**
- **11 Piece AS9411** Fractional sizes: 1/4", 5/16", 11/32", 3/8", 7/16", 1/2", 9/16", 5/8", 11/16", 3/4", 7/8" **\$99.95**



AS9411



AS9415

Flex Head Open End Combination Wrenches \$25.08

- Capable of tilting 180 degrees
- 72 teeth with double stack pawls to provide 144 tips (ratcheting positions)
- 144 tips provide wrench with more movement, a 2.5-degree space requirement for each turn
- Made with chrome vanadium steel for strength in Taiwan
- Designed for working in confined space
- **916FHOECW** - 9/16" Flex head
- **58FHOECW** - 5/8" Flex head



916FHOECW

ARE YOU READY?

EV Chargers Available by Autel

Ask about our other EV related TPMS, Lifts, and Diagnostic tools.

WANT TO KNOW WHAT OTHER EV FOCUSED PRODUCTS WE OFFER?

