

2007 CATALOG

HYDRAULICS CATALOG

Seals, Cylinders, Hoses and Power Units



all part

supply, inc.

ALLPART FOR ALL BRANDS



1-800-381-1330

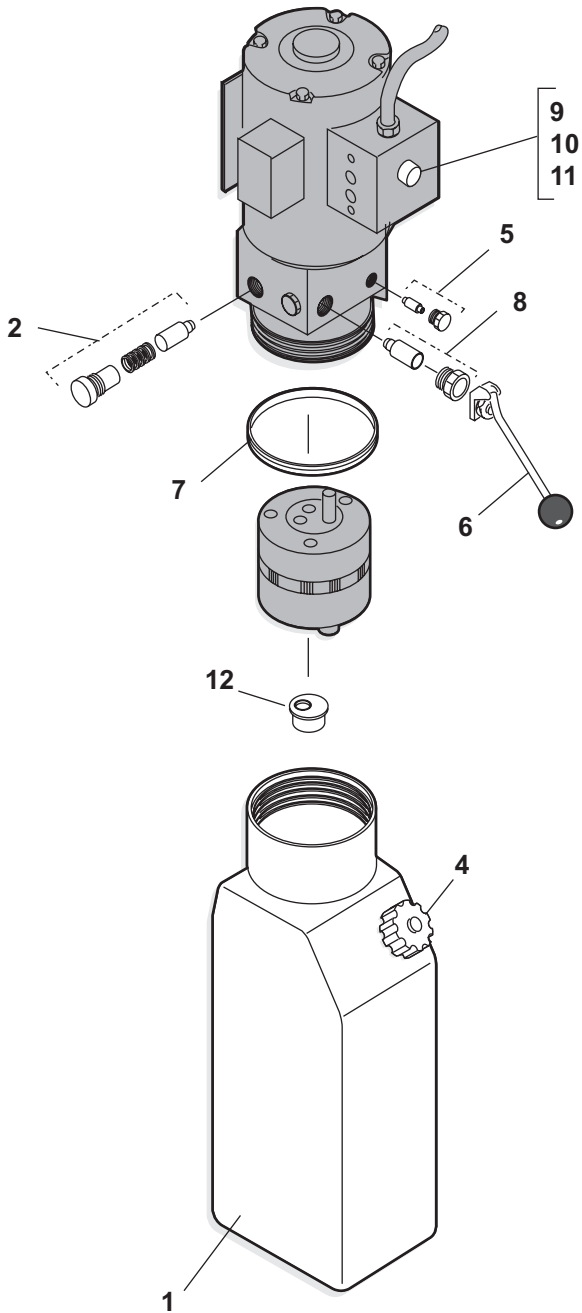

Table of Contents

Power Units	Page 2
Hydraulic Hoses	Page 5
Cylinders & Seals	Page 7
American, Lift Dist	Page 7
Ben Pearson	Page 9
Challenger	Page 13
Eagle	Page 16
Forward	Page 18
Gemini	Page 20
Grand, New Grand	Page 22
Manitowoc	Page 24
Nussabaum	Page 25
Rotary	Page 27
Western	Page 33
Wheeltronics	Page 35
Worth	Page 37

HYDRAULIC CYLINDERS & SEAL KITS

POWER UNITS



AB-1396 110V. / 3 GAL

ITEM NO.	PART NO.	DESCRIPTION
1	FE-5141-AC	RESERVOIR
2	FE-RV-18	FIXED RELIEF VALVE
3 (NOT SHOWN)	FE-1118-AA	PUMP/MOTOR SPLINE COUPLING
4	FE-260185	RESERVOIR BREATHER
5	FE-2507-AA	CHECK VALVE
6	FE-2565-AA	RELEASE HANDLE ASSY.
7	FE-G1-1073-48	RESERVOIR O-RING
8	FE-VF-9021	RELEASE VALVE CARTRIDGE
9	FE-4610-AA	START SWITCH BEZEL ASSY
10	FE-4612-AA	RUBBER BOOT FOR SWITCH
11	FE-4611-AA	MOMENTARY SWITCH CONTACT
12	FE-1611-AA	SUCTION STRAINER

HYDRAULIC CYLINDERS & SEAL KITS

POWER UNITS

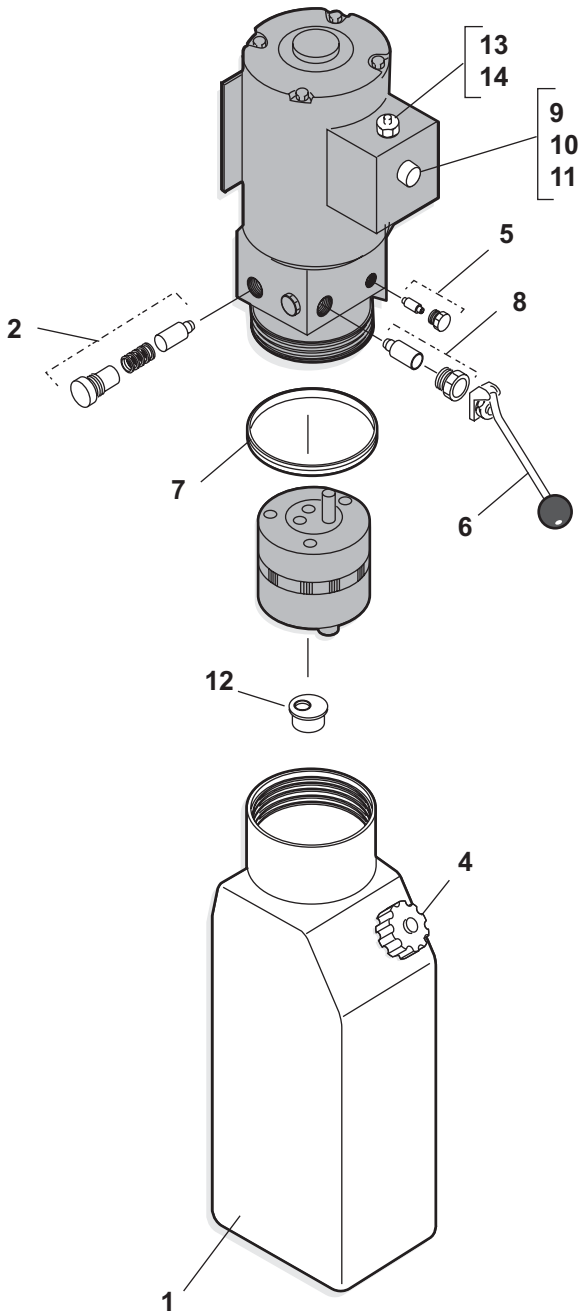

AB-1270 208-230V. / 3.5 GAL

ITEM NO.	PART NO.	DESCRIPTION
1	FE-5141-AC	RESERVOIR
2	FE-RV-19	FIXED RELIEF VALVE
3 (NOT SHOWN)	FE-1118-AA	PUMP/MOTOR SPLINE COUPLING
4	FE-260185	RESERVOIR BREATHER
5	FE-2507-AA	CHECK VALVE
6	FE-2565-AA	RELEASE HANDLE ASSY.
7	FE-G1-1073-48	RESERVOIR O-RING
8	FE-VF-9021	RELEASE VALVE CARTRIDGE
9	FE-4610-AA	START SWITCH BEZEL ASSY
10	FE-4612-AA	RUBBER BOOT FOR SWITCH
11	FE-4611-AA	MOMENTARY SWITCH CONTACT
12	FE-1611-AA	SUCTION STRAINER
13	FE-4043-AA	KILL SWITCH BODY ASSY
14	FE-4193-AA	KILL SWITCH MOMENTARY CONTACT

HYDRAULIC CYLINDERS & SEAL KITS

POWER UNITS

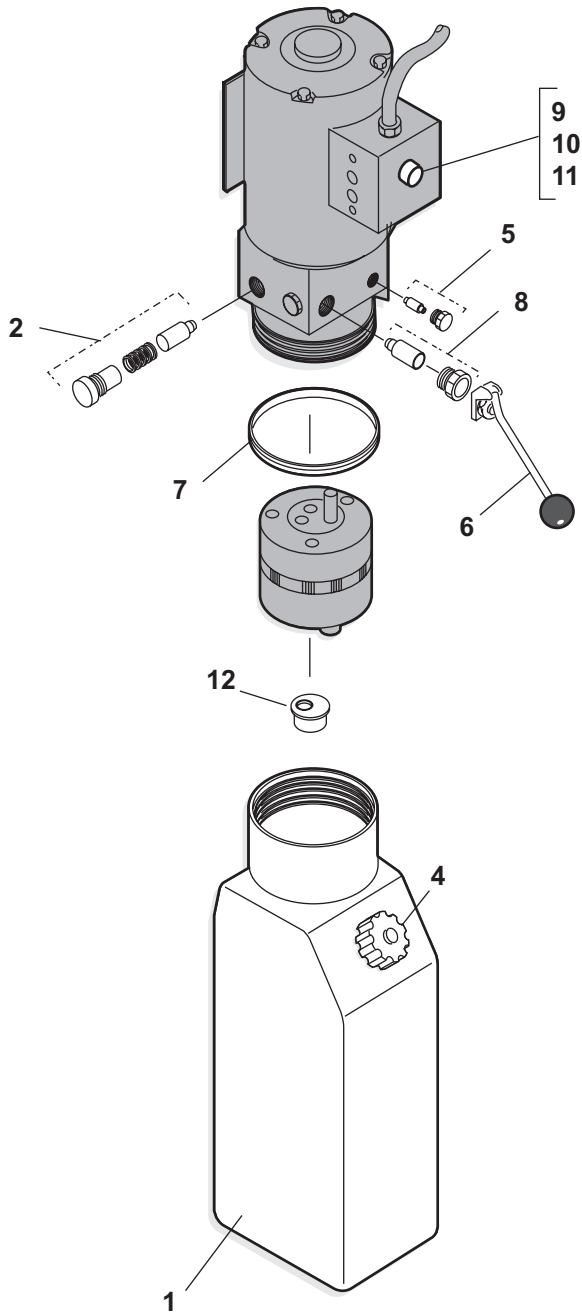

AB-1271-A 208-230V. / 6 GAL

ITEM NO.	PART NO.	DESCRIPTION
1	FE-R1-6000-11	RESERVOIR
2	FE-RV-17	FIXED RELIEF VALVE
3 (NOT SHOWN)	FE-1118-AA	PUMP/MOTOR SPLINE COUPLING
4	FE-1683-AB	RESERVOIR BREATHER
5	FE-2507-AA	CHECK VALVE
6	FE-2565-AA	RELEASE HANDLE ASSY.
7	FE-G1-1073-48	RESERVOIR O'RING
8	FE-VF-9021	RELEASE VALVE CARTRIDGE
9	FE-4610-AA	START SWITCH BEZEL ASSY
10	FE-4612-AA	RUBBER BOOT FOR SWITCH
11	FE-4611-AA	MOMENTARY SWITCH CONTACT
12	FE-1611-AA	SUCTION STRAINER

HYDRAULIC CYLINDERS & SEAL KITS

HYDRAULIC FITTINGS

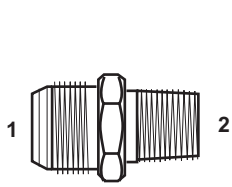

F2404
FO-MP STRAIGHT

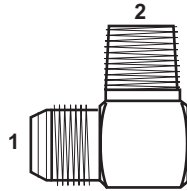

F2501
FO-MP 90°

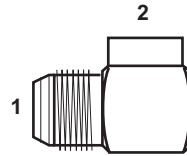

F2502
FO-FP 90°

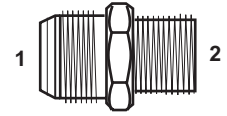

F6400-O
FO-MORB STRAIGHT

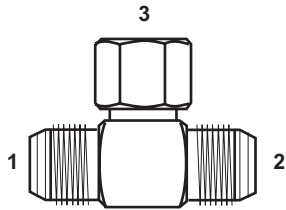

F6600
FO-FO-FJS TEE

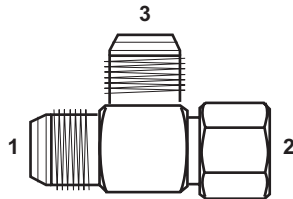

F6602
FO-FJS-FO TEE

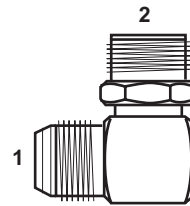

F6801-NWO
FO-MAORB 90°

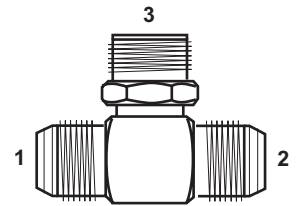

F6803-NWO
FO-FO-MAORB TEE

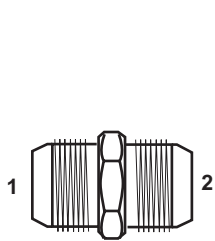

2403
MJ-MJ STRAIGHT

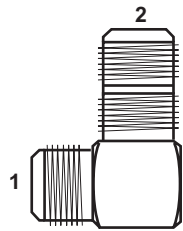

2701
MJ-MJ
BULKHEAD 90°

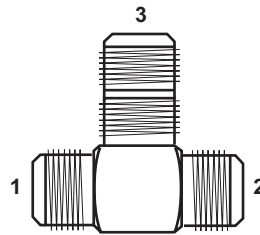

2703
MJ-MJ-MJ
BULKHEAD BRANCH TEE

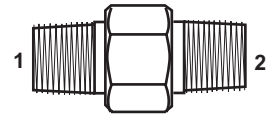

5404
MP-MP HEX NIPPLE

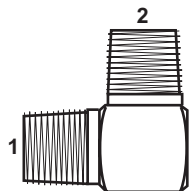

5500
MP-MP 90°

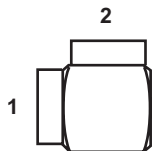

5504
FP-FP 90°
STREET ELBOW

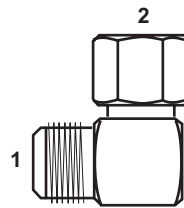

6500
MJ-FJS 90°

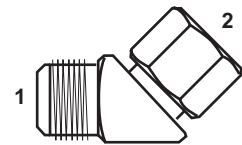

6502
MJ-FJS 45°

HYDRAULIC CYLINDERS & SEAL KITS

HYDRAULIC HOSES



FEMALE JIC
STRAIGHT

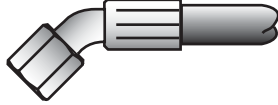

FEMALE JIC
45°



FEMALE JIC
90°



MALE PIPE SWIVEL
STRAIGHT

HOSE SIZE	JIC STRAIGHT	JIC 45	JIC 90	PIPE STRAIGHT
1/4"	04G-04FJX	04G-04FJX45	04G-04FJX90	04G-04MPX
3/8"	06G-06FJX	06G-06FJX45	06G-06FJX90	06G-06MPX
1/2"	08G-08FJX	08G-08FJX45	08G-08FJX90	08G-08MPX

HYDRAULIC CYLINDERS & SEAL KITS

AMERICAN LIFT, LIFT DISTRIBUTORS

2 POST LIFTS

7,000 LBS CAPACITY

CYLINDER	SEALS	NOTES
EA-021-000 2.5" BORE X 36" STROKE	AM-25001500AA	ARLINGTON AUTO 1.50" SHAFT
	AM-25001750AA	ARLINGTON AUTO 1.75" SHAFT
	AM-25001500CAN	READY MACHINE 1.50" SHAFT
	AM-25001750CAN	READY MACHINE 1.75" SHAFT
	AM-25001500THI	TEXAS HYDRAULICS
	AM-25001500KER	IMPORT

2.5" & 3" CYLINDERS

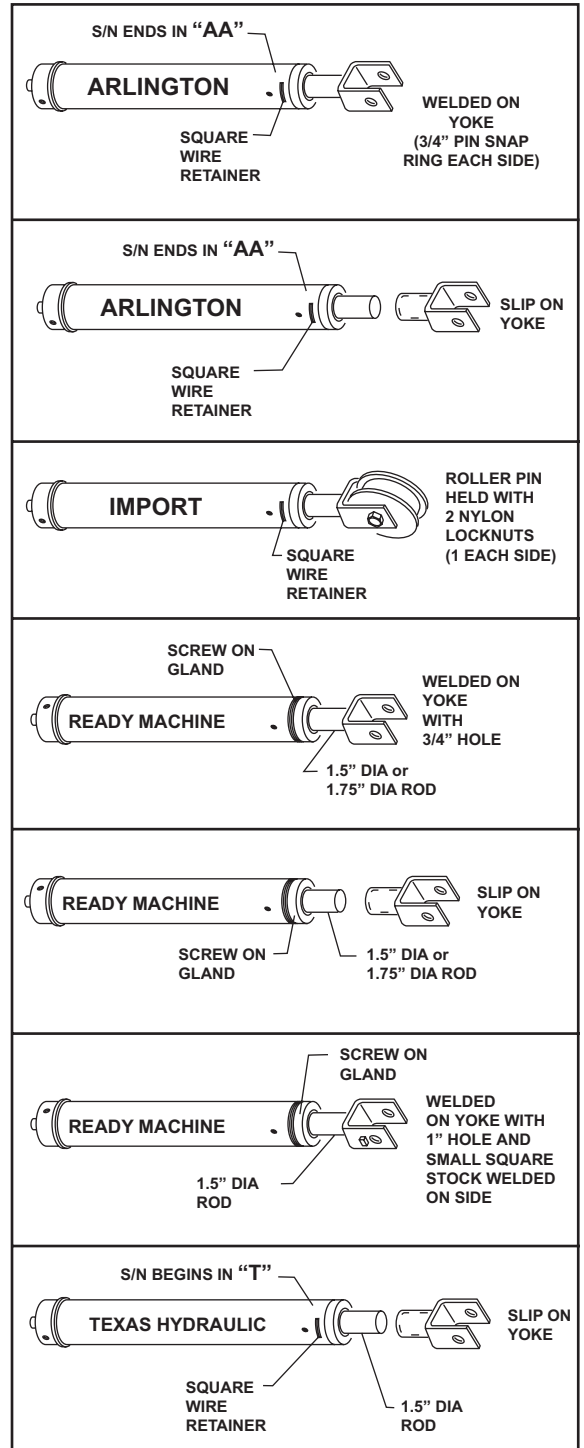

9,000 to 12,000 LBS CAPACITY

CYLINDER	SEALS	NOTES
EA-021-001 3" BORE X 36" STROKE	AM-30001750AA	ARLINGTON AUTO 1.75" SHAFT
	AM-30001500AA	ARLINGTON AUTO 1.50" SHAFT
	AM-30001500CAN	READY MACHINE 1.50" SHAFT
	AM-30001750CAN	READY MACHINE 1.75" SHAFT
	AM-30001500THI	TEXAS HYDRAULICS
	AM-30001750KER	IMPORT

15,000 LBS CAPACITY

CYLINDER	SEALS	NOTES
EA-021-005 3-1/2" BORE X 36" STROKE	AM-35001750CAN	READY MACHINE 1.75" SHAFT

HYDRAULIC CYLINDERS & SEAL KITS

AMERICAN LIFT, LIFT DISTRIBUTORS

4 POST LIFTS

12,000 LBS CAPACITY - CHAIN STYLE		
CYLINDER	SEALS	NOTES
EA-021-003 3-1/2" BORE X 72" STROKE	AM-35001500AA	ARLINGTON AUTOMATICS
	AM-35001500THI	TEXAS HYDRAULICS
	AM-35001500CAN	READY MACHINE
	AM-35001500DK	DAKOTA

18,000 LBS CAPACITY - CHAIN STYLE		
CYLINDER	SEALS	NOTES
EA-021-006 4" BORE X 72" STROKE	AM-40001500CAN	READY MACHINE
	AM-40001500DK	DAKOTA

25,000 to 30,000 LBS CAPACITY - CHAIN STYLE		
CYLINDER	SEALS	NOTES
EA-021-008 5" BORE X 60" STROKE	AM-50001500AA	ARLINGTON AUTOMATICS
	AM-50001500THI	TEXAS HYDRAULICS
	AM-50001500CAN	READY MACHINE
	AM-50001500DK	DAKOTA

40,000 to 60,000 LBS CAPACITY - CHAIN STYLE		
CYLINDER	SEALS	NOTES
AM-632 6" BORE X 32" STROKE	AM-60003000CAN	READY MACHINE

70,000 to 80,000 LBS CAPACITY - CHAIN STYLE		
CYLINDER	SEALS	NOTES
AM-732 7" BORE X 32" STROKE	AM-70003000CAN	READY MACHINE

12,000 - 30,000 LBS LIFTS

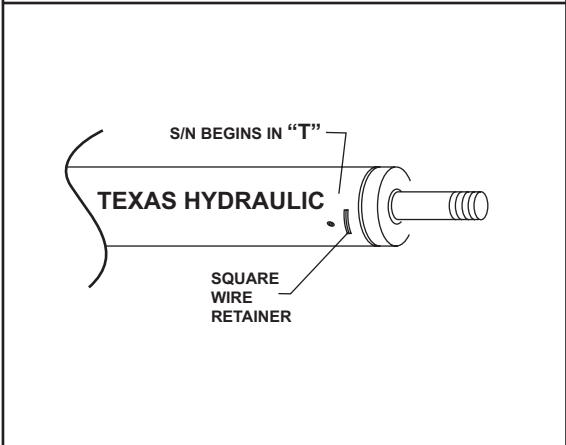
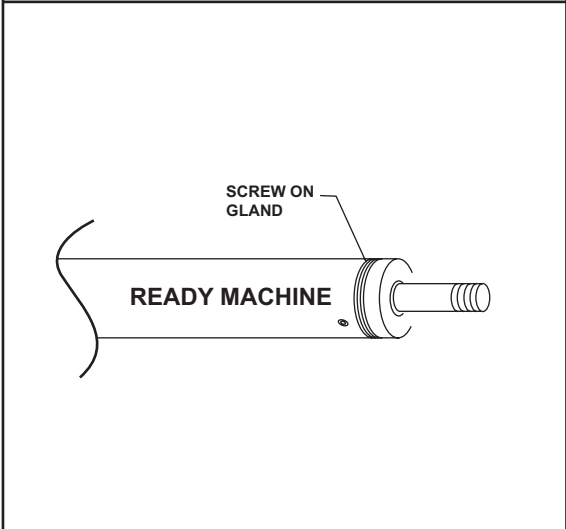
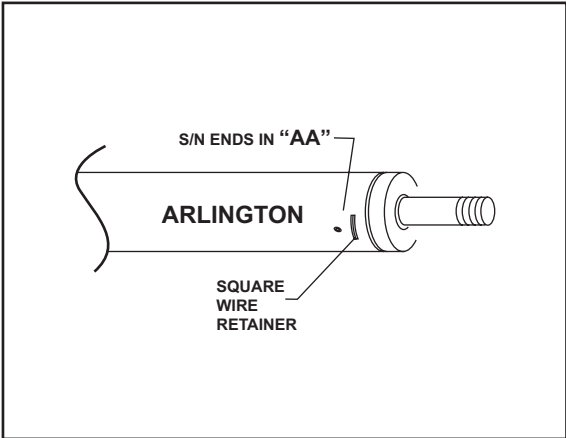

HYDRAULIC CYLINDERS & SEAL KITS

BEN PEARSON

2 POST LIFTS

AO MECHANICAL, AF MECHANICAL, & AL-7		
CYLINDER	SEALS	NOTES
BP-82803	BP-82860	HOLMAC (ALLEN)
	BP-83339	MF-PACOMA (HEX)

LAS7, LASO7, & LM07		
CYLINDER	SEALS	NOTES
BP-81821	BP-81821SK	(UNIVERSAL)

LMP7, LSP7		
CYLINDER	SEALS	NOTES
BP-81821	BP-80748	Serial # < 41833 Fits Cyl #80674
	BP-81821SK	Serial # > 41833 (UNIVERSAL)

LAS9, LASO9, LMO9, LMP9		
CYLINDER	SEALS	NOTES
BP-81921	BP-81921SK	UNIVERSAL KIT

LMP7, LSP7		
CYLINDER	SEALS	NOTES
BP-81921	BP-80813	Serial # < 41937 Fits Cyl #80800
	BP-81921SK	Serial # > 41937 (UNIVERSAL)

HYDRAULIC CYLINDERS & *SEAL KITS*

BEN PEARSON

2 POST LIFTS

NDL5500, NDL7000		
CYLINDER	SEALS	NOTES
BP-83542	BP-83657	HOLMAC (ALLEN)
	BP-83339	MF-PACOMA (HEX)

NDF7, NDO7, NDF9, NDO9		
CYLINDER	SEALS	NOTES
BP-83542	BP-83657	HOLMAC (ALLEN)
	BP-83339	MF-PACOMA (HEX)

LFS 9, LFSO 9		
CYLINDER	SEALS	NOTES
BP-82080 PUMP SIDE	BP-81798	CESSNA CYL
BP-82081 OFF SIDE	BP-81799	CESSNA CYL

9000A, 9000F, 9000S		
CYLINDER	SEALS	NOTES
BP-91454	BP-91454SK	CHAIN OVER

12000S		
CYLINDER	SEALS	NOTES
BP-91474	BP-91457SK	INVERTED CYL

9000AI, 9000SI, 12000SI		
CYLINDER	SEALS	NOTES
BP-91586	BP-91586SK	INVERTED CYL

HYDRAULIC CYLINDERS & SEAL KITS

BEN PEARSON

2 POST LIFTS

9000FC MAGNUM		
CYLINDER	SEALS	NOTES
BP-91732	BP-91732SK	CHAIN OVER

BEN PEARSON

4 POST LIFTS

LMT9, SST9 & 12, LMA9 & 12, FAR9 & 12		
CYLINDER	SEALS	NOTES
BP-80078	BP-80078SK	UNIVERSAL

LMT12		
CYLINDER	SEALS	NOTES
BP-80078	BP-80141	SERIAL # < 22316
	BP-80078SK	UNIVERSAL

12000AL, 12000AS, 12000-4ML, 12000MR		
CYLINDER	SEALS	NOTES
BP-91132	BP-91132SK	UNIVERSAL

LTC 9		
CYLINDER	SEALS	NOTES
BP-81299	BP-81299SK	UNIVERSAL

HYDRAULIC CYLINDERS & SEAL KITS

BEN PEARSON

4 POST LIFTS

QLR-2000		
CYLINDER	SEALS	NOTES
BP-81311	BP-81311SK	UNIVERSAL

LMT22		
CYLINDER	SEALS	NOTES
BP-80410	BP-81915	PRINCE
	BP-80455	LANTEX

LMT30		
CYLINDER	SEALS	NOTES
BP-80817	BP-82123	PRINCE

25000-4, 25000-4W, 30000-4, 30000-4W		
CYLINDER	SEALS	NOTES
BP-91197	BP-91197SK	UNIVERSAL

HYDRAULIC CYLINDERS & SEAL KITS

CHALLENGER

2 POST LIFTS

15000, 15002, 18000, 18002

CYLINDER	SEALS	NOTES
CH-15005 2.5" BORE x 69" STROKE	CH-11191	MF-PACOMA

CL10, CL9

CYLINDER	SEALS	NOTES
CH-16138 2" BORE x 68" STROKE	CH-11014	MF-PACOMA

39000S

CYLINDER	SEALS	NOTES
CH-36135 2" BORE x 65" STROKE	CH-11014	MF-PACOMA

12000, 36000, 37000, 39000, 70000, 71000

CYLINDER	SEALS	NOTES
ORIGINAL 36115 2" BORE x 72" STROKE	CH-11014	MF-PACOMA
REPLACEMENT CH-39097 2" BORE x 72" STROKE	CH-11019	HOLMAC
	CH-11018	ARLINGTON AUTOMATICS

20000, 21000, 26000, 27000, 28000, 30000, 31000, 33000, 35000

CYLINDER	SEALS	NOTES
ORIGINAL 200001 2.5" BORE x 36.5" STROKE	CH-11013	HOLMAC
	CH-11012	ARLINGTON AUTOMATICS
	CH-11037	BRUNING
	CH-11038	LANTEX
	CH-11062	MF-PACOMA
REPLACEMENT CH-31265 2.5" BORE x 36.5" STROKE	CH-11075	MARION - 3" X 36.5" STROKE

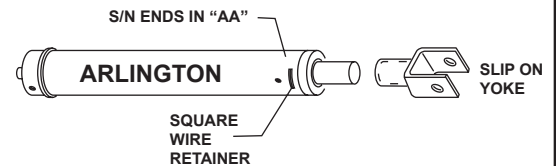

2.5" BORE x 36.5" STROKE

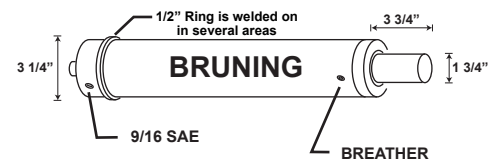

On the top gland removal are 2 spiral lock rings along with a spacer.
Dimensions are as follows: Top Spiral Ring 2.400" OD x 2.130" ID
Next Ring 2.5" OD x 2.400" ID (it is split on 1 side)
Internal Spiral Ring 2.662" OD x 2.290" ID

2.5" BORE x 36.5" STROKE

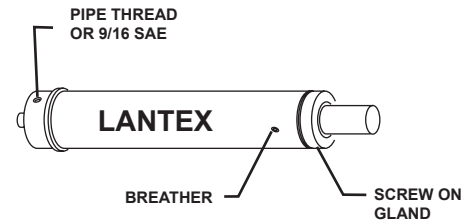

2.5" BORE x 36.5" STROKE

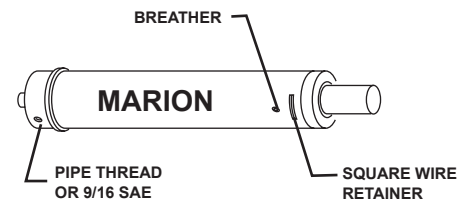

3" BORE x 36.5" STROKE

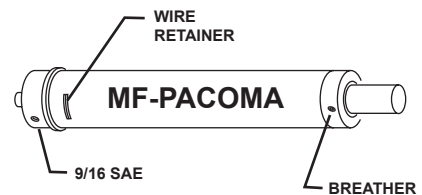

2.5" BORE x 36.5" STROKE

HYDRAULIC CYLINDERS & SEAL KITS

CHALLENGER

4 POST LIFTS

12,000 - 30,000 LBS CHAIN STYLE LIFTS

12K CAPACITY - CHAIN STYLE		
CYLINDER	SEALS	NOTES
44000 SERIES (made by HOLMAC)		
CH-591-50-1620 3-1/2" BORE X 72" STROKE REPLACEMENT EA-021-003H	CH-591-50-1364	HOLMAC
24012 SERIES (made by AMERICAN LIFT)		
EA-021-003 3-1/2" BORE X 72" STROKE	AM-35001500AA	ARLINGTON AUTOMATICS
	AM-35001500THI	TEXAS HYDRAULICS
	AM-35001500CAN	READY MACHINE
	AM-35001500DK	DAKOTA
made by BEN PERSON		
BP-80078 3-1/2" BORE X 72" STROKE	BP-80078SK	UNIVERSAL

24018 (AR, ARXL, LR, XL)		
CYLINDER	SEALS	NOTES
EA-021-006 4" BORE x 72" STROKE	AM-40001500CAN	READY MACHINE
	AM-40001500DK	DAKOTA

24025 SERIES and 24030 SERIES		
CYLINDER	SEALS	NOTES
EA-021-008 5" BORE x 60" STROKE	AM-50001500AA	ARLINGTON AUTOMATICS
	AM-50001500THI	TEXAS HYDRAULICS
	AM-50001500CAN	READY MACHINE
	AM-50001500CAN	DAKOTA

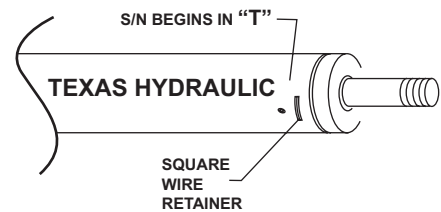
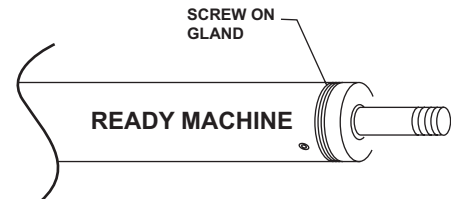
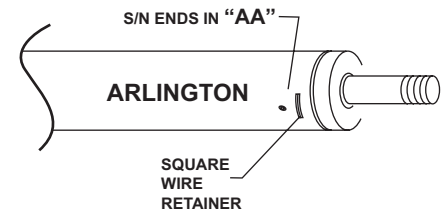

HYDRAULIC CYLINDERS & SEAL KITS

CHALLENGER

4 POST LIFTS

24050 SERIES and 24060 SERIES		
CYLINDER	SEALS	NOTES
AM-632 6" BORE x 32" STROKE	AM-60003000CAN	READY MACHINE

24080 SERIES		
CYLINDER	SEALS	NOTES
AM-732 7" BORE x 32" STROKE	AM-70003000CAN	READY MACHINE

40000 SERIES, 40E, 40N, 40S - CABLE LIFT		
CYLINDER	SEALS	NOTES
CH-40080 3.25" BORE x 60" STROKE	CH-501-59-1821	HOLMAC
CH-44011 3.25" BORE x 72" STROKE	44011SK	MF-PACOMA

44 (EAX, EFX, XAX, XFX, XRX) - CHAIN STYLE		
CYLINDER	SEALS	NOTES
CH-44011 2.5" BORE x 69" STROKE	CH-44011SK	

HYDRAULIC CYLINDERS & SEAL KITS

EAGLE

2 POST LIFTS

2.5" & 3" CYLINDERS

7,000 TO 9,000 LBS CAPACITY		
CYLINDER	SEALS	NOTES
EA-021-000 2.5" BORE X 36" STROKE	AM-25001500AA	ARLINGTON AUTO 1.5" SHAFT
	AM-25001750AA	ARLINGTON AUTO 1.75" SHAFT
	AM-25001500CAN	READY MACHINE 1.5" SHAFT
	AM-25001750CAN	READY MACHINE 1.75" SHAFT
	AM-25001500KEROS	IMPORT OLD STYLE
	AM-25001500KER	IMPORT NEW STYLE

10,000 TO 15,000 LBS CAPACITY		
CYLINDER	SEALS	NOTES
EA-021-001 3" BORE X 36" STROKE	AM-30001500AA	ARLINGTON AUTO 1.50" SHAFT
	AM-30001750AA	ARLINGTON AUTO 1.75" SHAFT
	AM-30001500CAN	READY MACHINE 1.50" SHAFT
	AM-30001750CAN	READY MACHINE 1.75" SHAFT
	AM-30001750KEROS	IMPORT OLD STYLE
	AM-30001750KER	IMPORT NEW STYLE

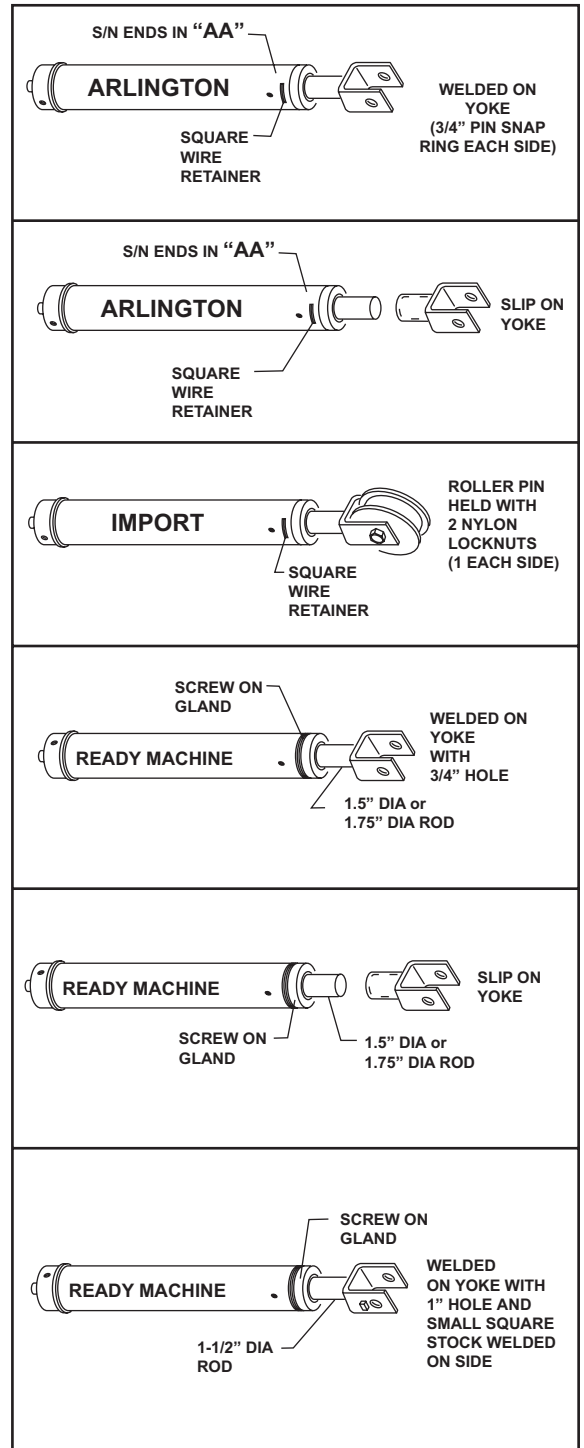

HYDRAULIC CYLINDERS & SEAL KITS

FORWARD

2 POST LIFTS

7000, 8000A, 9000, 9000B, 9100, 9200AR

CYLINDER	SEALS	NOTES
ORIGINAL CYL. FO-992301	FO-991192	WALTCO
	FO-991193	TMS
REPLACEMENT CYLINDER EA021-000	FO-991284	PRINCE
	FO-991305	HOLMAC
	FO-991512	TEXAS HYDRAULICS
	FO-992301	ARLINGTON AUTOMATICS

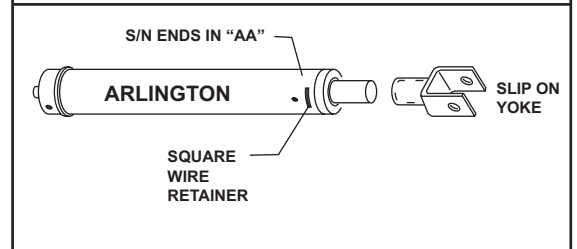
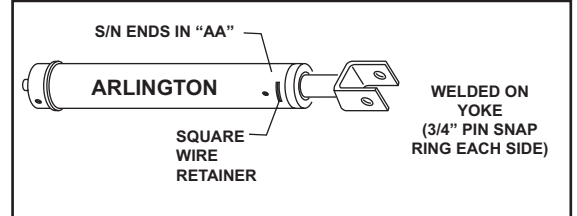

7000A, 9000A, ALL DP 9 and 10 Series

CYLINDER	SEALS	NOTES
FO-992317 2.5" BORE X 67.5" STROKE	FO-991281	PRINCE 2" X 67.5"
	FO991510	TEXAS HYDRAULICS
	FO-992317	ARLINGTON AUTOMATICS

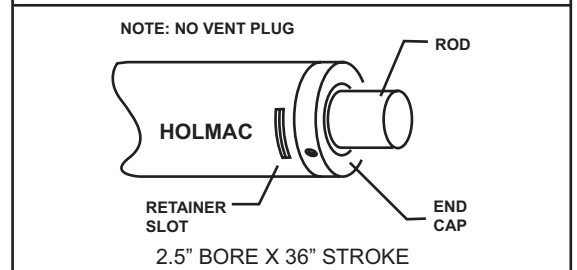

DPO12 SERIES, DPO15 Series

CYLINDER	SEALS	NOTES
FO-992322 3" BORE X 68" STROKE	FO-P000709	PRINCE
	FO-991511	TEXAS HYDRAULICS

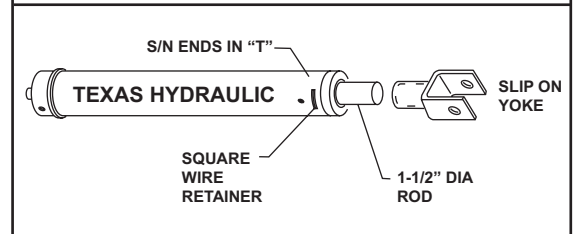

2 POST - 12000 with SINGLE CYLINDER

NOTE: SEE DRAWINGS FOR 12K 4 POST CYLINDERS ON FOLLOWING PAGE

CYLINDER	SEALS	NOTES
ORIGINAL CYL. FO-992302 3.5" BORE X 72" STROKE	FO-991194	WALTCO
	FO-991195	TMS
	FO-991282	PRINCE
REPLACEMENT CYLINDER EA-021-003	FO-991306	HOLMAC
	AM-35001500THI	TEXAS HYDRAULICS
	AM-35001500AA	ARLINGTON AUTOMATICS

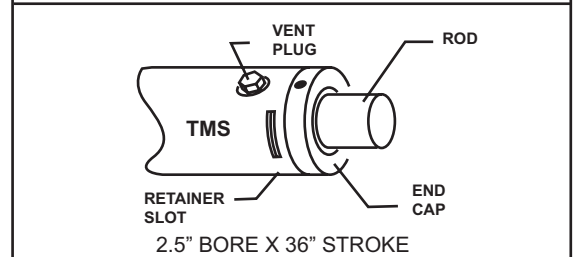
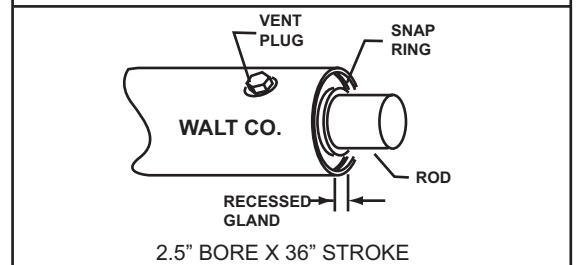

HYDRAULIC CYLINDERS & SEAL KITS

FORWARD

4 POST LIFTS

12000 Series (AR, LR, EL, LIMO)		
CYLINDER	SEALS	NOTES
ORIGINAL CYL. FO-992302	FO-991194	WALTCO
	FO-991195	TMS
REPLACEMENT CYLINDER EA-021-003	FO-991282	PRINCE
	FO-991306	HOLMAC
	AM-35001500THI	TEXAS HYDRAULIC
	AM-35001500AA	ARLINGTON AUTOMATICS

18000, 27000, 40000, and 50000 Series		
CYLINDER	SEALS	NOTES
FO-992304	FO-991283	PRINCE
	FO-991307	HOLMAC
	FO-991308	WALTCO
	FO-991309	TMS
	AM-50001500THI	TEXAS HYDRAULIC
	AM-50001500AA	ARLINGTON AUTOMATICS

60000 Series		
CYLINDER	SEALS	NOTES
FO-992326	FO-992326SK	6" BORE X 60" STROKE

12,000 - 50,000 LBS LIFTS

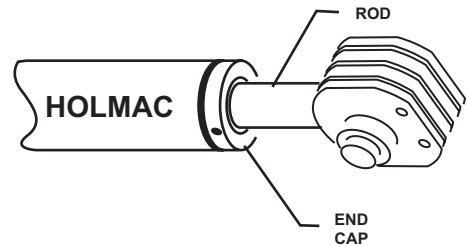
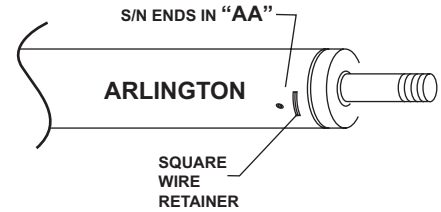

NOTE: CHAIN CONNECTOR
WELDED TO ROD

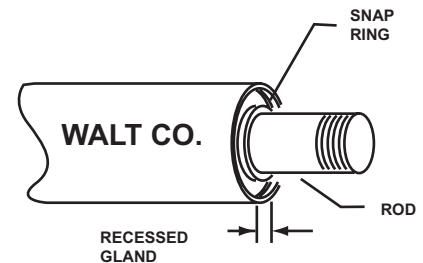
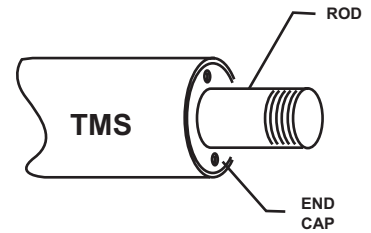
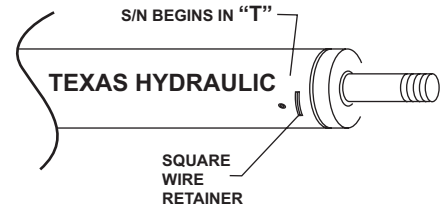

HYDRAULIC CYLINDERS & SEAL KITS

GEMINI

2 POST LIFTS

7,000 TO 9,000 LBS CAPACITY		
CYLINDER	SEALS	NOTES
EA-021-000 2.5" BORE X 36" STROKE	AM-25001500CAN	READY MACHINE - 1.50" SHAFT
	AM-25001750CAN	READY MACHINE - 1.75" SHAFT
	AM-25001500KER	IMPORT

10,000 TO 15,000 LBS CAPACITY		
CYLINDER	SEALS	NOTES
EA-021-001 3" BORE X 36" STROKE	AM-30001500CAN	READY MACHINE 1.50" SHAFT
	AM-30001750CAN	READY MACHINE 1.75" SHAFT
	AM-30001750KER	IMPORT

2.5" & 3" CYLINDERS

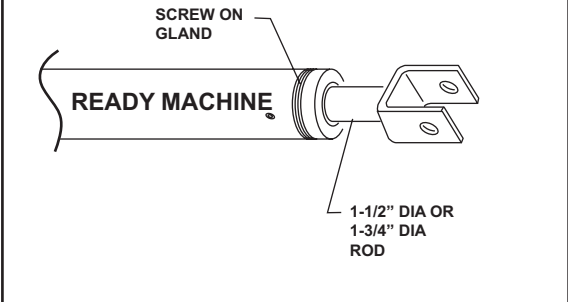
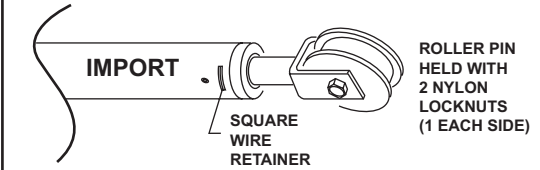

HYDRAULIC CYLINDERS & SEAL KITS

GEMINI

4 POST LIFTS

SS-LIFTS - 7,000 TO 9,000 LBS CAPACITY - CABLE STYLE

CYLINDER	SEALS	NOTES
EA-021-002 3" BORE X 70" STROKE	GE-3070SK	READY MACHINE - SCREW-IN GLAND
	EA-3070	IMPORT - SQUARE WIRE RETAINER RING

XLT-LIFTS - 7,000 TO 9,000 LBS CAPACITY - CABLE STYLE

CYLINDER	SEALS	NOTES
EA-021-007 3" BORE X 80" STROKE	GE-3080	READY MACHINE - SCREW-IN GLAND
	EA-3080	IMPORT - SQUARE WIRE RETAINER RING

12,000 TO 15,000 LBS CAPACITY - CHAIN STYLE

CYLINDER	SEALS	NOTES
EA-021-003 3.5" BORE X 72" STROKE	AM-35001500CAN	READY MACHINE 1.5"
	AM-35001500KER	IMPORT

25,000 TO 27,000 LBS CAPACITY - CHAIN STYLE

CYLINDER	SEALS	NOTES
EA-021-004 5.5" BORE X 60" STROKE	GE-55001750CAN	READY MACHINE
	GE-55001750KER	IMPORT
- OR - FO-992304 5" BORE X 60" STROKE	AM-50001500CAN	READY MACHINE

12,000 - 30,000 LBS LIFTS

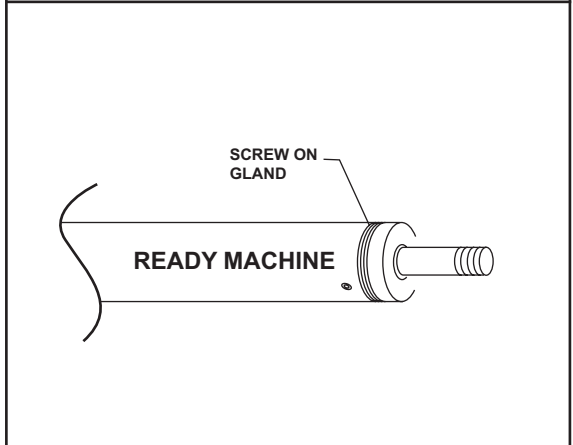
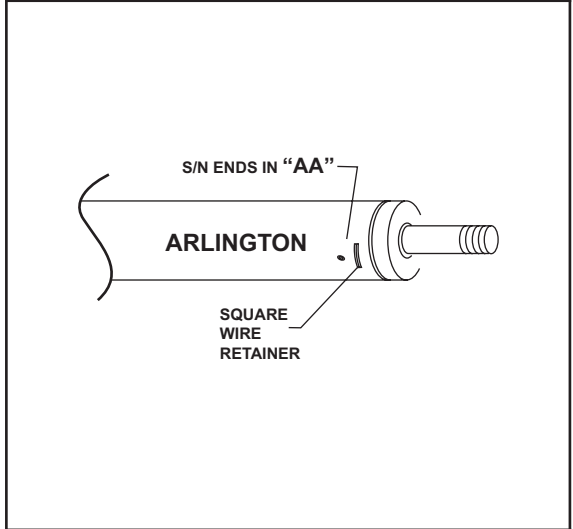
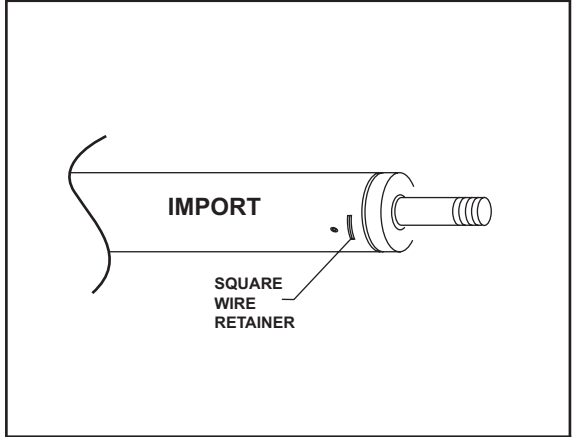

HYDRAULIC CYLINDERS & SEAL KITS

GRAND & NEW GRAND

2 POST LIFTS

7,000 TO 9,000 LBS CAPACITY		
CYLINDER	SEALS	NOTES
EA-021-000 2.5" BORE X 36" STROKE	AM-25001500AA	ARLINGTON AUTO 1.5" SHAFT
	AM-25001750AA	ARLINGTON AUTO 1.75" SHAFT
	AM-25001500THI	TEXAS HYDRAULICS

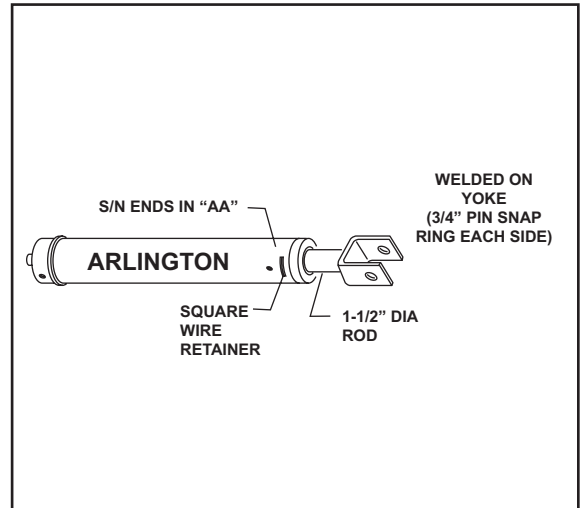

10,000 TO 15,000 LBS CAPACITY		
CYLINDER	SEALS	NOTES
EA-021-001 3" BORE X 36" STROKE	AM-30001500AA	ARLINGTON AUTO 1.50" SHAFT
	AM-30001750AA	ARLINGTON AUTO 1.75" SHAFT
	AM-30001500THI	TEXAS HYDRAULIC

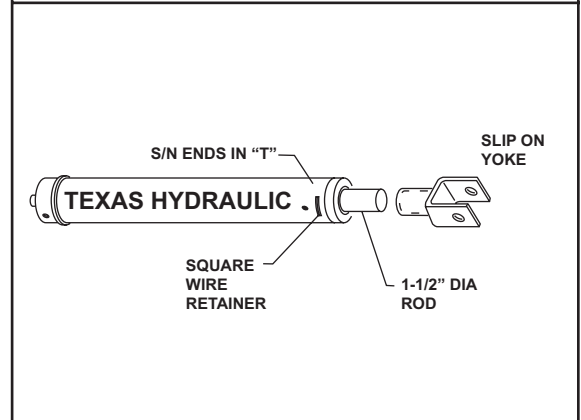
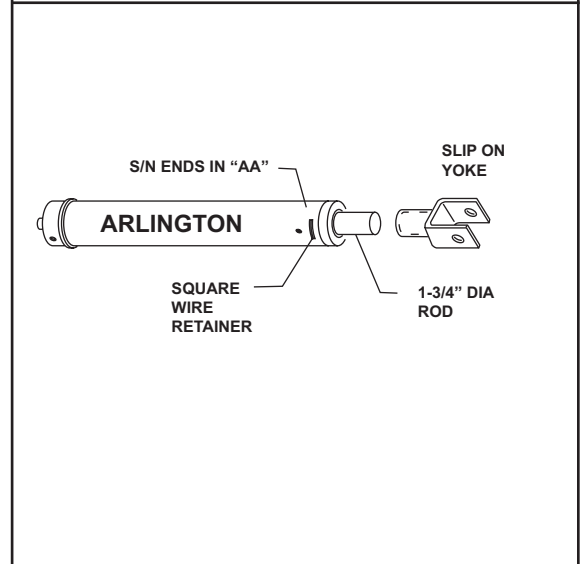

HYDRAULIC CYLINDERS & SEAL KITS

GRAND & NEW GRAND

4 POST LIFTS

12,000 TO 15,000 LBS CAPACITY - CHAIN STYLE

CYLINDER	SEALS	NOTES
EA-021-003 3.5" BORE X 72" STROKE	AM-35001500AA	ARLINGTON AUTOMATICS
	AM-35001500THI	TEXAS HYDRAULICS

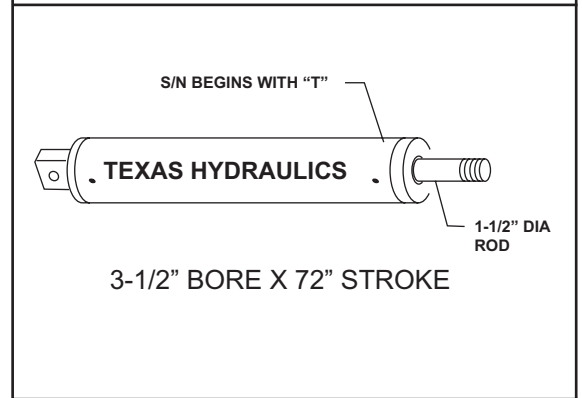
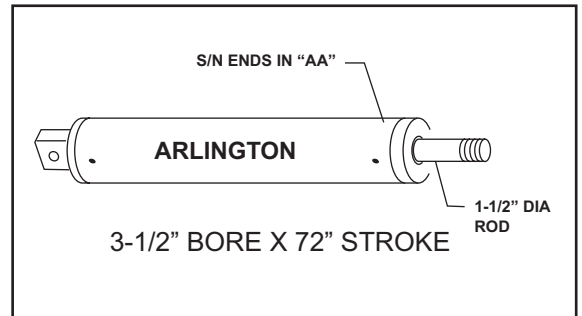

25,000 TO 27,000 LBS CAPACITY - CHAIN STYLE

CYLINDER	SEALS	NOTES
FO-992304 5" BORE X 60" STROKE	AM-50001500AA	ARLINGTON AUTOMATICS
	AM-50001500THI	TEXAS HYDRAULICS

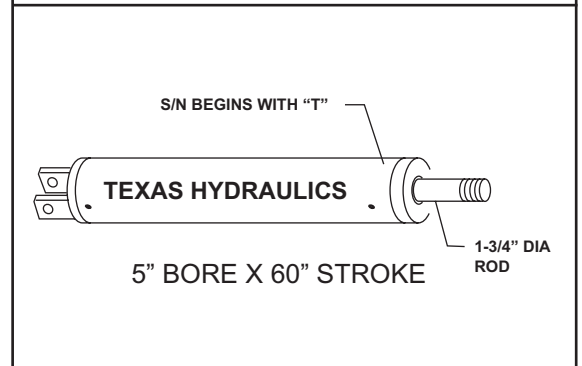
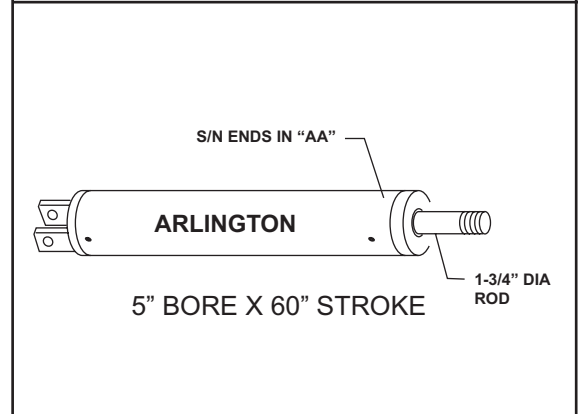

HYDRAULIC CYLINDERS &
SEAL KITS

MANITOWOC

2 POST LIFTS

CBT-70, 90, CFF-70, 70PL, 70S, CFF-90, 90PL, CFF-10000		
CYLINDER	SEALS	NOTES
MA-C-681-46	MA-K34159	

CL-9000, CLT-8000		
CYLINDER	SEALS	NOTES
MA-C-744-08	MA-K34345	

CFF-70N, CFF-90A		
CYLINDER	SEALS	NOTES
MA-R18230-87	MA-K34159	

HYDRAULIC CYLINDERS & *SEAL KITS*

NUSSBAUM

2 POST LIFTS

SPL8000 & NPL 8000		
CYLINDER	SEALS	NOTES
MASTER SIDE NU-80.003	NU-20.036SK	
SLAVE SIDE NU-80.004	NU-20.037SK	

STL7000		
CYLINDER	SEALS	NOTES
15.706	CALL	CHAIN STYLE
NU-20.036	NU-20.036SK	MASTER SIDE - CABLE STYLE
NU-20.037	NU-20.037SK	SLAVE SIDE - CABLE STYLE

HEL7000		
CYLINDER	SEALS	NOTES
MASTER SIDE NU-10.064	CALL	
SLAVE SIDE NU-10.065	CALL	

HYDRAULIC CYLINDERS & SEAL KITS

NUSSBAUM

2 POST LIFTS

HDL12000		
CYLINDER	SEALS	NOTES
NU-25.032	NU-25.032SK	

UNI LIFT SERIES 3100, 3100T, 3300		
CYLINDER	SEALS	NOTES
MASTER SIDE NU-40.220	NU-40.220SK	
SLAVE SIDE NU-40.221	NU-40.221SK	

3300 WHEEL-FREE LIFT		
CYLINDER	SEALS	NOTES
MASTER SIDE NU-45.307	CALL	
SLAVE SIDE NU-45-308	CALL	

HYDRAULIC CYLINDERS & SEAL KITS

ROTARY

2 POST LIFTS

SP70, SP74

CYLINDER	SEALS	NOTES
RO-FJ76	RO-FJ76-12	UNIVERSAL KIT

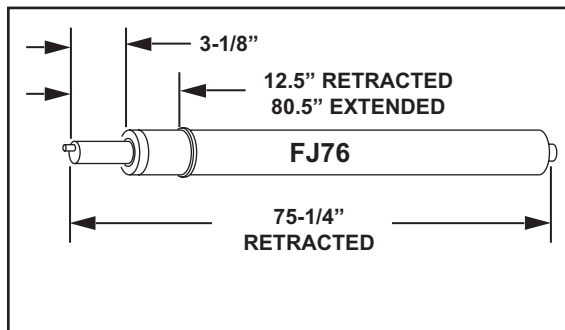

AR94, ARO94, SP55, SP94, SPOA84, SPO84, SPO94

CYLINDER	SEALS	NOTES
ORIGINAL FJ783	RO-FJ783-12TH	TEXAS HYDRAULICS
REPLACEMENT RO-FJ7375	RO-FJ783-12MF	MF - PACOMA
- OR -		
ORIGINAL FJ211	RO-FJ783-12TH	TEXAS HYDRAULICS
REPLACEMENT RO-FJ211	RO-FJ783-12MF	MF - PACOMA

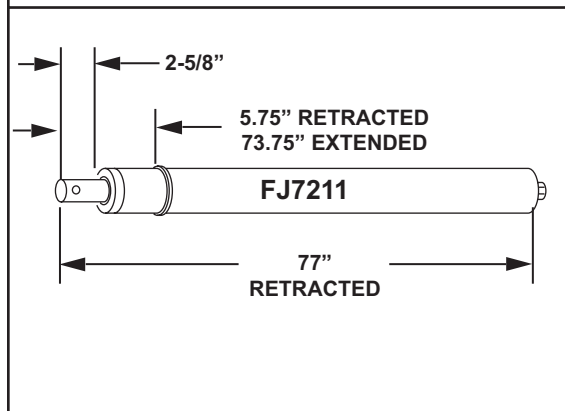
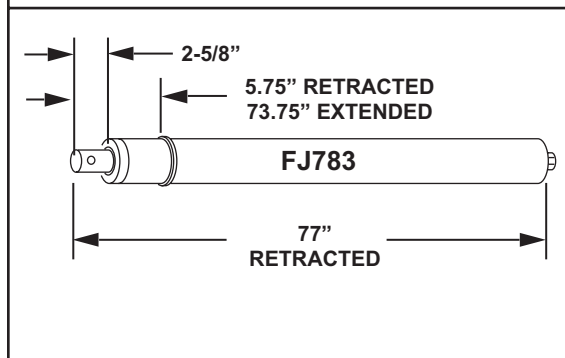

SP80 Series 1-3, SP84 Series 1-7

CYLINDER	SEALS	NOTES
RO-FJ20	RO-FJ20-12	BEST
	RO-FJ20-30	BEST OR TEXAS HYDRAULICS

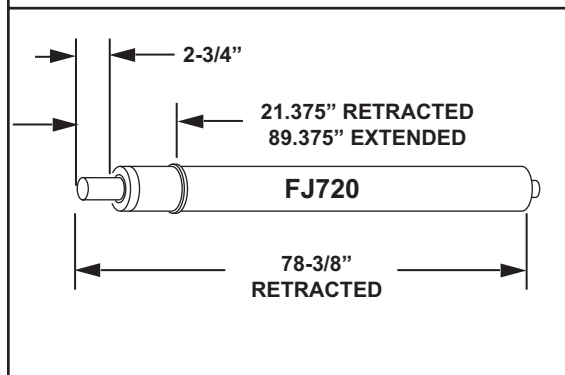

HYDRAULIC CYLINDERS & SEAL KITS

ROTARY

2 POST LIFTS

SP80 Series 4 & 5, SP84 Series 8 thru 11

CYLINDER	SEALS	NOTES
ORIGINAL FJ783	RO-FJ783-12TH	TEXAS HYDRAULICS
REPLACEMENT RO-FJ7375	RO-FJ783-12MF	MF - PACOMA
- OR -		
ORIGINAL FJ7211	RO-FJ783-12TH	TEXAS HYDRAULICS
REPLACEMENT RO-FJ7211	RO-FJ783-12MF	MF - PACOMA

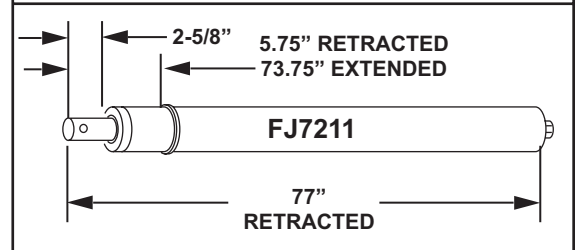
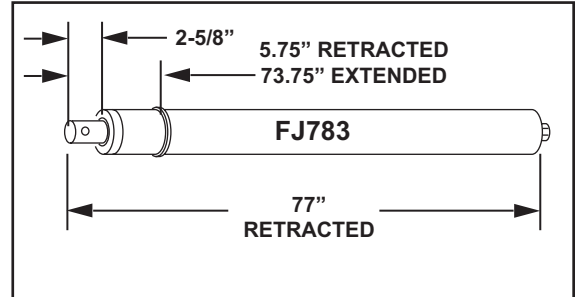

AR98, ARO98, DCOA7, SP88, SP98, SPO82, SPO88, SPO98, SPOA82, SPOA88, SPOA98

CYLINDER	SEALS	NOTES
RO-FJ7311	RO-FJ783-12TH	TEXAS HYDRAULICS
	RO-FJ783-12MF	MF - PACOMA

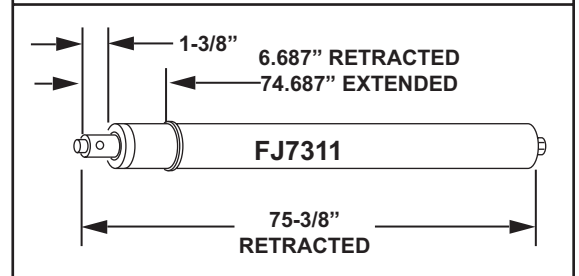

AR9, AR09, SL9, SL28, SP7, SP9, SPO7, SPO9, SPO10 (200 Series), SPOA7, SPOA9, TL07

CYLINDER	SEALS	NOTES
RO-FJ7664	RO-FJ783-12TH	TEXAS HYDRAULICS
	RO-FJ783-12MF	MF - PACOMA

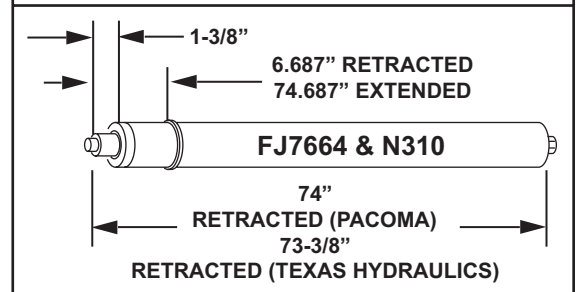

S15IP, S18IP, SL19, SPO12 (LC, Hummer, Sprinter), SPO15, & 15LC, SPO18

CYLINDER	SEALS	NOTES
RO-FJ7604	RO-FJ7604-12HP	MF - PACOMA
	RO-FJ7604-12TH	TEXAS HYDRAULIC

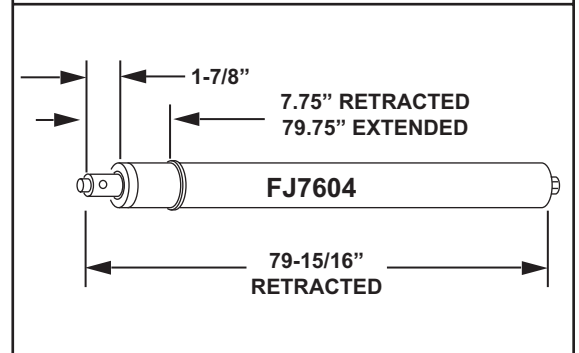

HYDRAULIC CYLINDERS & SEAL KITS

ROTARY

2 POST LIFTS

AN10I, AN10N, S10IB, SPO10 (500/700), SPOA10		
CYLINDER	SEALS	NOTES
ORIGINAL N342 (68" STROKE)	RO-N342-12	MF - PACOMA
REPLACEMENT RO-N380	RO-N342-13	PANNI
- OR -		
ORIGINAL N343 (71" STROKE)	RO-N342-12	MF - PACOMA
REPLACEMENT RO-N382	RO-N342-13	PANNI

SPO12		
CYLINDER	SEALS	NOTES
ORIGINAL N344 (68" STROKE)	RO-N342-12	MF - PACOMA
REPLACEMENT RO-N346	RO-N342-13	PANNI
- OR -		
ORIGINAL N345 (71" STROKE)	RO-N342-12	MF - PACOMA
REPLACEMENT RO-N347	RO-N342-13	PANNI

A71-HA, A7PIP, S12I (B, P, HMR, SPRINTER), TLO7		
CYLINDER	SEALS	NOTES
RO-N344 68" STROKE	RO-N342-12	MF - PACOMA
	RO-N342-13	PANNI
- OR -		
RO-N382 71" STROKE	RO-N342-12	MF - PACOMA
	RO-N342-13	PANNI

HYDRAULIC CYLINDERS & *SEAL KITS*

ROTARY

4 POST LIFTS

FLS12, FLS15		
CYLINDER	SEALS	NOTES
RO-FC5155	RO-FC5155-10TH	UNIVERSAL

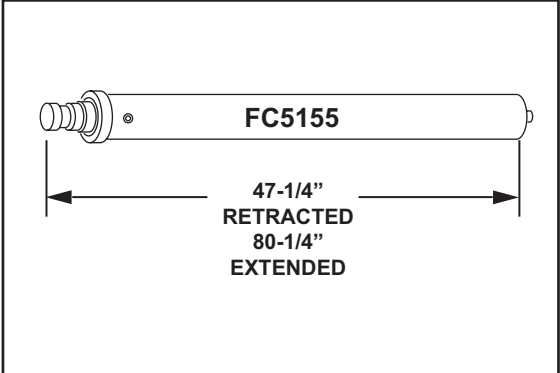

FLS25, SM250, SM270, SM271, SM272		
CYLINDER	SEALS	NOTES
RO-FC5225-15	RO-FC5225-70	UNIVERSAL SEAL KIT

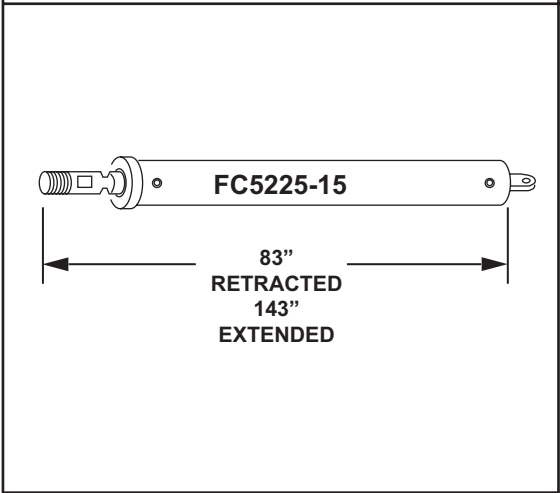

AR122, ARO122, QL4P, QLHV, SM122, SM122EL, SM122S		
CYLINDER	SEALS	NOTES
ORIGINAL FC5797 REPLACEMENT RO-FC5795-1	RO-FC5795-TH	UNIV. SEAL KIT FOR FC597 CYL.
- OR -		
ORIGINAL FC5342 (CLEVIS) REPLACEMENT RO-FC5797-1	RO-FC542-12TH	SEALS FOR ORIG. FC5342 CYL.
	RO-FC542-12MF	SEALS FOR ORIG. FC5342 CYL.
	RO-FC5767-TH	UNIV. SEAL KIT FOR FC5797 CYL.

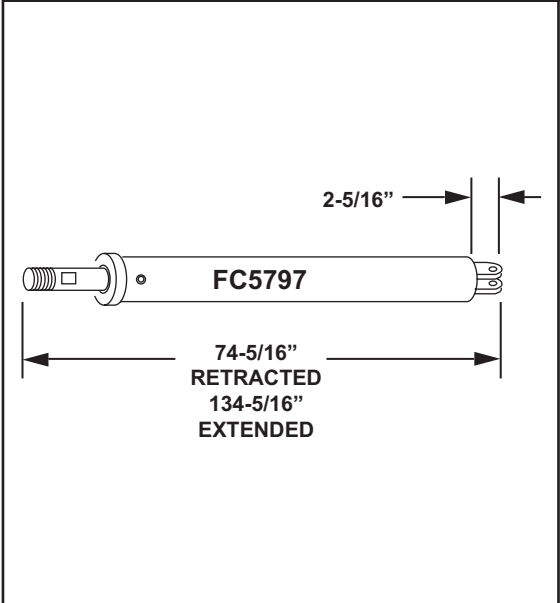

HYDRAULIC CYLINDERS & SEAL KITS

ROTARY

4 POST LIFTS

AR90, AR91, SM90, SM91, CWA90		
CYLINDER	SEALS	NOTES
ORIGINAL FC5343 (CLEVIS) REPLACEMENT RO-FC5343	RO-FC537-12TH	TEXAS HYDRAULICS
	ROFC-537-12MF	MF-PACOMA
- OR -		
ORIGINAL FC537 (BRACKET) REPLACEMENT RO-FC537-KIT	RO-FC537-12TH	TEXAS HYDRAULICS
	RO-FC537-12MF	MF-PACOMA

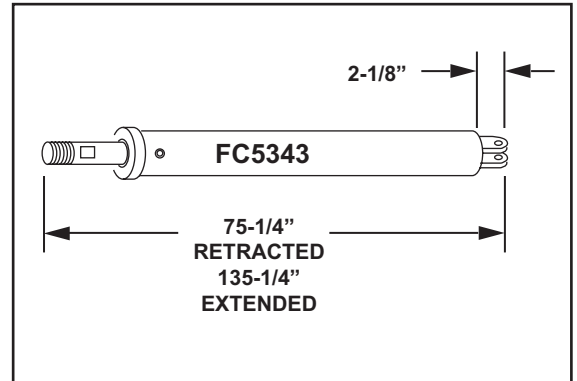

AR120, AR121, QL4P, QLHV, SM101, SM120, SM121, SWA120		
CYLINDER	SEALS	NOTES
ORIGINAL FC5342 REPLACEMENT RO-FC5797-1 (CLEVIS)	RO-FC542-12TH	SEALS FOR FC5342, TEXAS HYDRAULIC CLYINDER
	RO-FC542-12M	SEALS FOR FC5342, MF-PACOMA CLYINDER
	RO-FC5797-TH	SEALS FOR FC5797 CYLINDER
-OR-		
ORIGINAL FC542 (BRACKET) REPLACEMENT RO-FC542KIT	RO-FC542-12TH	SEALS FOR FC542, TEXAS HYDRAULIC CLYINDER
	RO-FC542-12MF	SEALS FOR FC542, MF-PACOMA CLYINDER

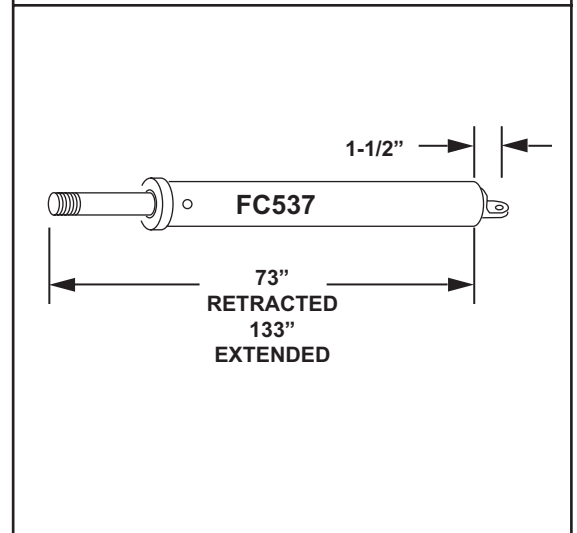

SM300 thru 302, SM500 thru 504, SM600 thru 604, SMA300 thru 302		
CYLINDER	SEALS	NOTES
RO-FC5761	RO-5761-12TH	TEXAS HYDRAULICS
	RO-15474	TEXAS HYDRAULICS

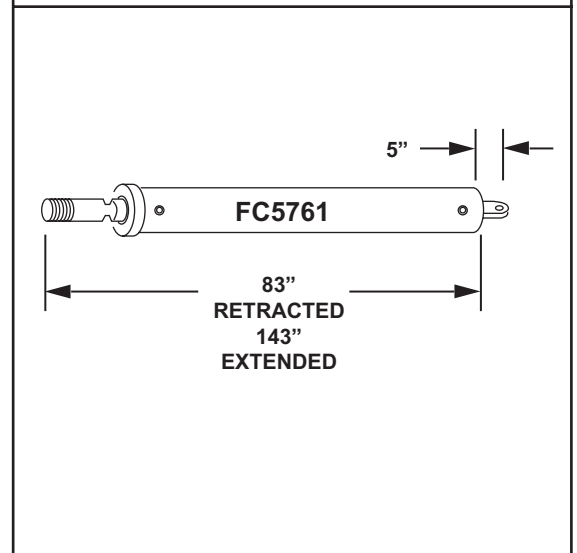

HYDRAULIC CYLINDERS & SEAL KITS

ROTARY

4 POST LIFTS

AR43, SM18, SM80, SM180, SM181		
CYLINDER	SEALS	NOTES
RO-FC5810-38	RO-FC5810-38-12TH	TEXAS HYDRAULICS

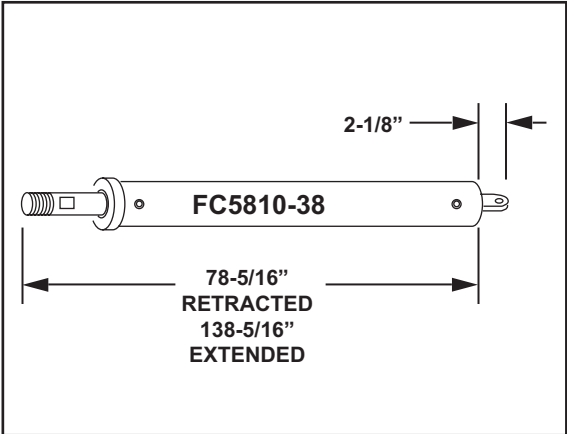

AR12, AR123, AR40, AR55, ARO12, ARO123		
CYLINDER	SEALS	NOTES
RO-S130002	RP-S130002-12HY	HYCO

SM121, SM123, SM40, SM54, SM55, SM88, SMO121, SMO123		
CYLINDER	SEALS	NOTES
RO-S130002	RP-S130002-12HY	HYCO

HYDRAULIC CYLINDERS & SEAL KITS

WESTERN

2 POST LIFTS

7,000 TO 9,000 LBS CAPACITY (CHAIN OVER)

CYLINDER	SEALS	NOTES
WE-S100 2.5" BORE	WE-S210	UNIVERSAL KIT

WLO- 12,000 LBS CAPACITY (CHAIN OVER)

CYLINDER	SEALS	NOTES
EA-021-001 3" BORE	AM-30001500AA	ARLINGTON AUTO 1.50" SHAFT
	AM-30001750AA	ARLINGTON AUTO 1.75" SHAFT
	AM-30001500CAN	READY MACHINE 1.50" SHAFT
	AM-30001750CAN	READY MACHINE 1.75" SHAFT
	AM-30001500THI	TEXAS HYDRAULIC
	AM-30001750KER	IMPORT

WLO- 15,000 LBS CAPACITY (CHAIN OVER)

CYLINDER	SEALS	NOTES
3.5" BORE	AM-35001750CAN	READY MACHINE 1.75" SHAFT

WSO90A / Y2K (2 POST)

CYLINDER	SEALS	NOTES
CALL	WE-S1021	

TIRE LIFT

CYLINDER	SEALS	NOTES
WE-S110	WE-S200	UNIVERSAL

3" CYLINDERS ONLY

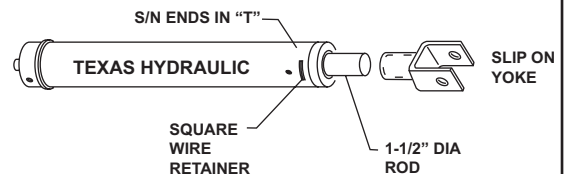
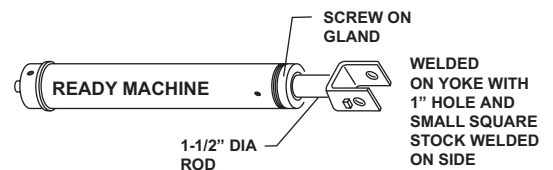
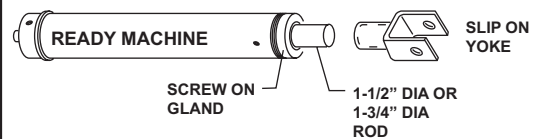
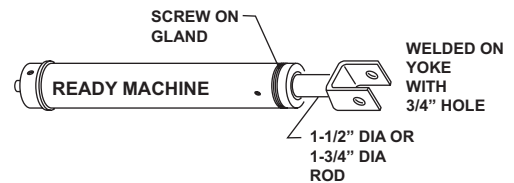
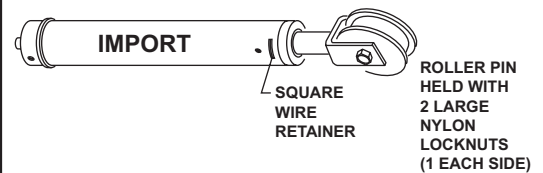
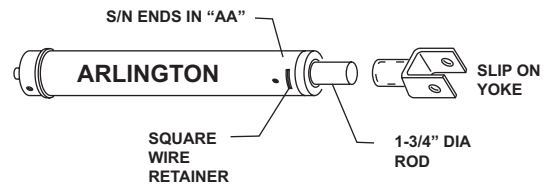

HYDRAULIC CYLINDERS & SEAL KITS

WESTERN

2 POST LIFTS

WRT-12 12,000 LBS CAPACITY - CHAIN STYLE

CYLINDER	SEALS	NOTES
EA-021-003 3.5" BORE X 72" STROKE	AM-35001500AA	ARLINGTON AUTOMATICS
	AM-35001500THI	TEXAS HYDRAULICS
	AM-35001500CAN	READY MACHINE
	AM-35001500KER	IMPORT

12,000 - 30,000 LBS CHAIN STYLE LIFTS

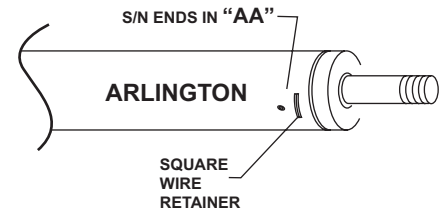

WRT-18 18,000 LBS CAPACITY - CHAIN STYLE

CYLINDER	SEALS	NOTES
EA-021-003 4" BORE X 72" STROKE	AM-40001500CAN	READY MACHINE

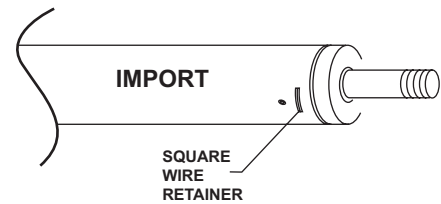

WFP-24

CYLINDER	SEALS	NOTES
EA-021-008	AM-50001500CAN	BLACK CYLINDER
	AM-50001500AA	BLUE CYLINDER

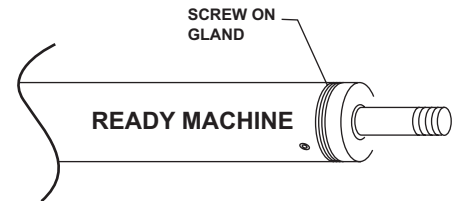

WRT-24, WRT-25, WRT-30

CYLINDER	SEALS	NOTES
EA-021-004 5.5" BORE X 60" STROKE	GE-55001750KER	IMPORT
	GE-55001750CAN	READY MACHINE
- OR -		
EA-021-008 5" BORE X 60" STROKE	AM-50001500AA	ARLINGTON AUTOMATICS
	AM-50001500CAN	READY MACHINE
	AM-50001500THI	TEXAS HYDRAULIC
	AM-50001500DK	DAKOTA

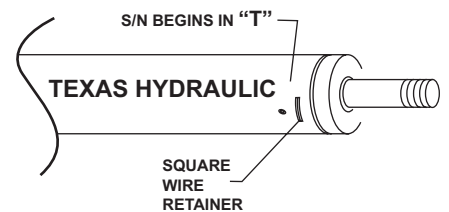

HYDRAULIC CYLINDERS & *SEAL KITS*

WHEELTRONICS

2 POST LIFTS

7144V, 8144V, 9144V, 11144VS			
CYLINDER	PISTON	GLAND	NOTES
3-0735	0-0159	0-0551	RIGHT SIDE
4-0289	0-0160	0-0206	LEFT SIDE

7144, 11168, 11168VS			
CYLINDER	PISTON	GLAND	NOTES
3-0480	0-0159	0-0207	RIGHT SIDE
4-0289	0-0160	0-0206	LEFT SIDE

7144, 8144 VECTOR			
CYLINDER	PISTON	GLAND	NOTES
3-0430	0-0159	0-0162	RIGHT SIDE
4-0289	0-0160	0-0206	LEFT SIDE

1776 SERIES, 1800 Series, 1969 Series DIRECT PULL, CABLE EQ. 9K-10K LBS			
CYLINDER	PISTON	GLAND	NOTES
3-0621	0-0337	0-0338	

7010, 7012			
CYLINDER	PISTON	GLAND	NOTES
3-0376	0-0159	0-0162	RIGHT SIDE
4-0227	0-0160	0-0182	LEFT SIDE

HYDRAULIC CYLINDERS & SEAL KITS

WHEELTRONICS

2 POST LIFTS

8020 Series, 8021			
CYLINDER	PISTON	GLAND	NOTES
4-0171	0-0159	0-0162	RIGHT SIDE
4-0173	0-0160	0-0161	LEFT SIDE

2012 Series			
CYLINDER	PISTON	GLAND	NOTES
3-0883	0-0159	0-0551	

WHEELTRONICS

4 POST LIFTS

10000 Series, 12000 Series			
CYLINDER	PISTON	GLAND	NOTES
4-0187	0-0169	0-0170	

14000 Series			
CYLINDER	PISTON	GLAND	NOTES
4-0393	0-0241	0-0242	3.5" CYLINDER

18000 Series			
CYLINDER	PISTON	GLAND	NOTES
3-0681			4" CYLINDER

HYDRAULIC CYLINDERS & SEAL KITS

WORTH

2 POST LIFTS

7,000 TO 9,000 LBS CAPACITY		
CYLINDER	SEALS	NOTES
EA-021-000 2.5" BORE X 36" STROKE	AM-25001500AA	ARLINGTON AUTO 1.50" SHAFT
	AM-25001750AA	ARLINGTON AUTO 1.75" SHAFT
	AM-25001500CAN	READY MACHINE 1.50" SHAFT
	AM-25001750CAN	READY MACHINE 1.75" SHAFT
	AM-25001500THI	TEXAS HYDRAULICS
	AM-25001500KER	IMPORT

10,000 TO 15,000 LBS CAPACITY		
CYLINDER	SEALS	NOTES
EA-021-001 3" BORE X 36" STROKE	AM-30001500AA	ARLINGTON AUTO 1.50" SHAFT
	AM-30001750AA	ARLINGTON AUTO 1.75" SHAFT
	AM-30001500CAN	READY MACHINE 1.50" SHAFT
	AM-30001750CAN	READY MACHINE 1.75" SHAFT
	AM-30001500THI	TEXAS HYDRAULIC
	AM-30001750KER	IMPORT

2.5" & 3" CYLINDERS

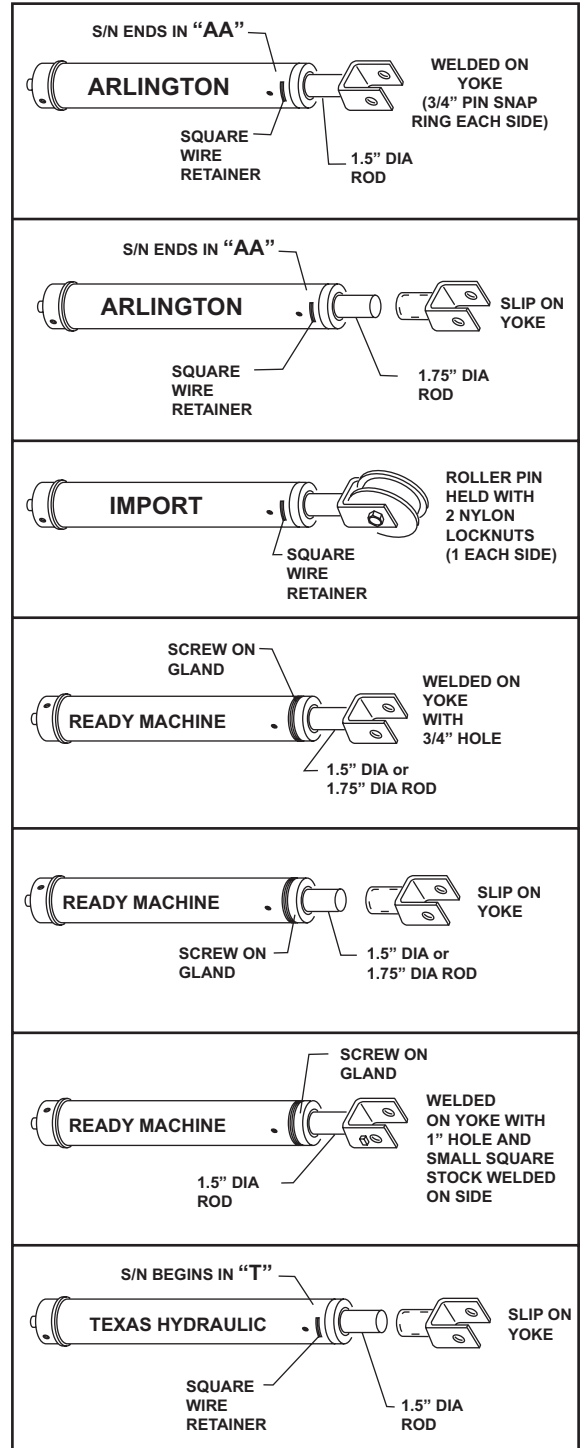

HYDRAULIC CYLINDERS & SEAL KITS

WORTH

4 POST LIFTS

12,000 TO 15,000 LBS CAPACITY - CHAIN STYLE

CYLINDER	SEALS	NOTES
EA-021-003 3.5" BORE X 72" STROKE	AM-35001500AA	ARLINGTON AUTOMATICS
	AM-35001500THI	TEXAS HYDRAULICS
	AM-35001500CAN	READY MACHINE
	AM-35001500KER	IMPORT

25,000 TO 30,000 LBS CAPACITY - CHAIN STYLE

CYLINDER	SEALS	NOTES
EA-021-004 5.5" BORE X 60" STROKE	GE-55001750CAN	READY MACHINE
	GE-55001750KER	IMPORT
- OR -	// // // // //	
EA-021-008 5" BORE X 60" STROKE	AM-50001500AA	ARLINGTON AUTOMATICS
	AM-50001500THI	TEXAS HYDRAULICS
	AM-50001500CAN	READY MACHINE

12,000 - 30,000 LBS LIFTS

