

Balcrank[®]

**TIGER[®] 500
MODEL 1130-001
5:1 PUMP
GENERAL LUBE**





Thoroughly read and understand this manual before installing, operating or servicing this equipment.

**OPERATION, INSTALLATION,
MAINTENANCE AND REPAIR GUIDE**

GENERAL SAFETY REQUIREMENTS

NOTE: THOROUGHLY READ AND UNDERSTAND THIS MANUAL BEFORE INSTALLING, OPERATING OR SERVICING THIS EQUIPMENT.

	<p>! IMPORTANT</p>
<p>Because this pump can be incorporated into pressurized systems, the following safety precautions should be observed.</p> <p>Check equipment regularly and repair or replace worn and damaged parts.</p> <p>Never alter or modify any parts of this pump, doing so may cause damage to pump and/or personal injury.</p> <p>Under no circumstances should the dispensing valve be aimed at any person at any time. Personal injury may result.</p> <p>Release pressures built up in the system before any service or repair is begun. See the pressure relief procedure below.</p> <p>Do not operate this pump above 150 PSI (10.3 BAR) air inlet pressure or 200 cycles per minute.</p> <p>Always read and follow the fluid manufacturer's recommendations regarding the use of protective eyewear, clothing and respirators.</p>	
	<p>! WARNING</p>
<p>PRESSURE RELIEF PROCEDURE:</p> <p>Follow this procedure whenever you shut off the pump, when checking or servicing any part of the system and when installing, cleaning or changing any part of the system.</p> <ol style="list-style-type: none"> 1) Disconnect the air to the pump. 2) Point dispensing valve away from yourself and others. 3) Open dispensing valve until pressure is relieved. 	

	<p>! WARNING</p>
<p>THIS PUMP CONTAINS ALUMINUM AND ZINC PARTS. DO NOT use 1-1-1 Trichloroethane, methylene chloride or other halogenated hydrocarbon solvents or fluids containing such solvents in this pump. Use of these solvents/fluids may result in a violent chemical reaction, causing serious bodily injury, property damage or death. All fluids used in this pump must be chemically compatible with the wetted parts materials shown on page three (3) of this manual. Consult your chemical supplier to ensure compatibility.</p>	

	<p>! WARNING</p>
<p>Pump develops 750 PSI (51 BAR) maximum working pressure at 150 PSI (10.3 BAR) maximum inlet air pressure. Be sure that any components or accessories used in the system are rated to withstand this pressure. To determine fluid outlet pressure, multiply the ratio of the pump by the air pressure being used.</p> <p>EX: 5 (5:1 ratio) x 100 PSI = 500 PSI fluid pressure. 5 (5:1 ratio) x 6.8 BAR = 34 BAR fluid pressure.</p>	

	<p>! WARNING</p>
<p>DANGER: Not for use with fluids that have a flash point below 100°F (38°C). Examples: gasoline, alcohol. Sparking could result in an explosion which could result in death.</p>	

	<p>! WARNING</p>
<p>In the presence of explosive vapors, take action to prevent static sparking. Failure to ground the pump, piping, valves, containers, or other miscellaneous equipment can result in fire or explosion. A green grounding lug is provided on the pump.</p>	

GENERAL DESCRIPTION

The Balcrank Tiger® 500 pump is a high quality, reliable pump for petroleum based lubrication products. It is ideal for system distribution of fluids such as oil, automatic transmission fluid and pure antifreeze. It is rated for maximum air pressure of 150 PSI (10.3 BAR) and an average working air pressure of 100 PSI (6.8 BAR).

All air motor parts are lubricated at the factory with a special synthetic grease (Balcrank #826733) for improved life. A lightly lubricated, filtered and regulated air supply will prolong air motor maintenance intervals. DO NOT OVER LUBRICATE. Set lubricator to a maximum of 2 drops per hour of operation and use a turbine oil of 150-170 SSU (at 100°F).

The internal air motor and a 360 degree internal muffler provide efficient operation with low noise levels conforming to 1994 OSHA requirements.

The Tiger® 500 air motor is internally valved and very simple, with few moving parts. It is constructed of aluminum and steel with Buna-N seals for long life. The fluid section contains a steel pump rod, tube and fluid piston for rugged duty and high quality seals for long life. The fluid section is also double acting to provide consistent delivery. All of these features make the Tiger® 500 a top performing, long life, easy to service lubrication pump.

TECHNICAL DATA

Pressure Ratio.....	5:1
Air Motor Bore	4.25" (effective 3.25")
Stroke	3.50"
Displacement.....	9.2 in cycle
Cycles/gallon	25
Operating Air Pressure ..	0-150 PSI (0-10.3 BAR)
Air Consumption	28 CFM *
Suction Lift.....	20 in. Hg **
Air Inlet	3/8" NPT
Fluid Inlet.....	1" NPT
Fluid Outlet	3/4" NPT
Wetted Parts.....	Steel, Aluminum, Acetal, Buna-N and Nylon
Shipping Weight	23.5 lbs.

* tested at 100 psi air pressure, 3.04 ft³ per gallon

** 15' vertical suction maximum

INSTALLATION



WARNING: Attach a proper ground wire to the Tiger's grounding lug (item 38) before starting the pump.

After removing pump from carton, attach suction tube or hose securely. NOTE: Performance will be affected by a seal that is not air tight. If using the universal bung adapter, thread bung adapter into bung bushing, lower pump into bung adapter and tighten. If using the foot mount adapter, thread the suction tube into the adapter, attach to the bung bushing, thread pump onto bung adapter. If mounting on a tank or wall bracket, place pump in tank or wall bracket and tighten bolts securely. Always tighten pump down securely to avoid damage to fluid container, pump and nearby equipment.

Blow out any foreign material from the air supply line before connecting it to the pump. An air line filter/regulator is recommended for all applications as wet, dirty air will shorten the life of the air motor. This pump has been designed and assembled to operate on unlubricated air in regular duty installations. For heavy duty operations, a lubricator may be used with turbine oil of 150-170 SSU (at 100°F) set at a maximum of 2 drops per hour of operation. The air motor has been coated during assembly with a special synthetic grease (Balcrank #826733) so no additional air line lubrication is normally necessary. This special grease must be reapplied during each reassembly of the air motor.

Be sure air supply is turned off before connecting to the pump. Gradually open air regulator or air line valve until pump begins to cycle. The pump should prime within one to three cycles depending on the viscosity of the pumped material. Pump a small amount of fluid at low air pressure to remove trapped air and foreign materials from the line. Discard this waste material in conformance with local and/or state regulations.

After the system is fully primed, open the air supply regulator until desired flow and/or pressure is obtained. Always use the lowest pressure needed to provide the desired results, this reduces wear on all of the system components.

PUMP DISASSEMBLY

	! WARNING
	PRESSURE RELIEF PROCEDURE: Follow this procedure whenever you shut off the pump, when checking or servicing any part of the system and when installing, cleaning or changing any part of the system. 1) Disconnect the air to the pump. 2) Point dispensing valve away from yourself and others. 3) Open dispensing valve until pressure is relieved.

Tools required for disassembly/assembly: 5/32" allen wrench, 3/8", 7/16", 1/2" and 1-1/16" hex wrenches, 1-1/4" to 3" spanner wrench and pipe wrench.

- 1) Using a soft jaw vice, clamp the pump horizontally on the lower body (10). Remove four body screws (29) and star washers (11), remove cap (9). Remove three air valve nuts (5), washers (31), and screws (30). Remove upper toggle plate (22). Remove three spacers (24) and o-rings (26).
- 2) Clamp on adapter flats (21) and unscrew upper air piston (20). Remove lower toggle plate (23), springs (13 & 27), and trip plate (25).
- 3) Remove foot valve (6) and pump tube (7). Holding on to the hex of the air piston adapter (21), remove fluid piston assembly (43 & 44). Remove adapter (16) by unscrewing four adapter screws (40) and lock washers (1).
- 4) Slide lower air piston (37) pump rod (34) assembly out the top of the pump body (10). Take care not to scratch the pump rod, minor scratches can be polished out with #320 grit, wet or dry paper.
- 5) Place adapter (16) in a vice and remove the seal nut (17). Inside the seal nut (17) is the seal housing (18), the rod seal (8) and the rod seal o-ring (36).
- 6) Replace all o-rings, the rod seal (8), the rod seal o-ring (36), the fluid piston quad-ring seal (47) and wear ring (35), the air motor valve (27) and all springs (3, 12, 13 & 27).

PUMP REASSEMBLY

NOTE: The air motor is lubricated with a life-tested synthetic grease (Balcrank P/N 826733) at the factory. This grease coats all parts and repels air line moisture to prevent rusting. It is imperative that any grease removed during routine maintenance be replaced. Contact your Balcrank® service distributor, using the above part number, for replacement grease.

- 1) Reassemble rod seal cartridge (8, 18 & 36) and place in floating seal nut (17), assure that o-ring (36) is in correct location. Thread assembled floating seal nut (17) into the adapter (16) securely. Place large o-ring (15) in groove in pump body.
- 2) Place muffler (33) and muffler screen (32) into pocket inside lower end of the pump body (10). Place o-ring (15) in groove in pump body (10). Bolt adapter (16) to lower pump body (10) with four adapter screws (40) and four lock washers (1), tighten securely. Slide air piston/rod assembly (37 & 34) into lower body (10) and out through adapter (16). **FROM THE TOP ONLY! Any other assembly procedure will damage the rod seal (8)!**
- 3) Place lower pump body (10) horizontally in a suitable fixture. Assemble fluid piston by placing spring (3) and ball (2) in piston chamber (43), placing o-ring (45) on fluid piston nut (44) and threading nut (44) on securely. Place fluid piston seal (47) and wear-ring (35) on exterior of the fluid piston nut (44) and place o-ring (46) in groove below threads on piston chamber (43). While holding flats on air piston adapter (21), thread fluid piston assembly on to pump rod (34), tighten securely. Place o-ring (41) below external threads on the pump tube (7). Grease fluid piston seal (47) liberally, slide pump tube (7) over fluid piston (43 & 44) and thread into adapter (16) securely.
- 4) Assemble footvalve (6) by placing ball (2) in chamber and placing retaining pin (4) into holes, place o-ring (42) below external threads on footvalve. Thread footvalve (6) into tube (7), tighten securely. **Take care that all o-rings are replaced correctly to avoid leaks.**
- 5) Place trip plate (25), then lower springs (13 & 27), then lower toggle plate (23) onto air piston adapter (21). Screw upper air piston (20), with o-ring (14) in groove, onto air piston adapter (21), tighten securely. Place three o-rings between upper air piston (20) and lower toggle plate (23), centering them between holes in both plates. Place three spacers (24) into upper air piston (20) holes, through o-rings (26) and centering them over holes on lower toggle plate (23).
- 6) Place three air valve screws (30) through upper toggle plate (22), spacers (24) and lower toggle plate (23). Place washers (31) and nuts (5) on air valve screws and tighten securely. **Assure that all o-rings have been placed correctly to avoid leaks.**
- 7) Place o-ring (19) on lower body pump (10), around step. Grease air piston o-ring (14) liberally. Carefully slide air motor cap (9) down over air piston (20) taking care not to pinch the o-ring (14). Bolt cap (9) to body with four body screws (29) and four star washers (11), tighten securely to prevent leaks. Install air line fittings into air inlet hole in the cap. Install suction tube or hose into footvalve and install fluid outlet hose into fluid outlet in adapter.

TROUBLESHOOTING

Trouble	Probable Cause	Corrective Action
Pump does not operate	Inadequate air supply pressure or restricted air line Clogged lines, hoses, valves, etc. Damaged air motor	Increase or clear air supply ⁽¹⁾ Assure air is on and valves are open Open; clear ⁽¹⁾ Service air motor
Air motor is not tripping over	Air motor seals are worn/damaged	Service air motor
Air is leaking from exhaust and or seal damage, etc.	Air motor seals are worn/damaged	Service air motor
Fluid is leaking from the exhaust	Fluid seal (36) is worn/damaged	Replace
Erratic pump operation	Air entering suction line Fluid level too low Air motor icing	Check for loose connections Refill, reprime or flush Run pump at lower pressure; run at lower cycles per minute; clean muffler (33)
Pump runs continuously	Empty fluid supply Blockage in pump tube or foot valve (6) Lower ball (2) is stuck in foot valve (6) Lower seal (47) is worn or damaged	Refill, reprime or flush Remove pump tube, clear blockage Replace ball and reseal foot valve Replace
Fluid output on one stroke only or continues to operate when dispensing valve is closed	Upper ball (2) is stuck in fluid piston (44) or one or both are damaged	Replace ball and reseal
Pump operates, but pump output on both strokes is low	Inadequate air supply pressure or restricted air line Closed or clogged solenoid valve, meter, dispensing valve, etc. Air inlet strainer/filter clogged	Increase air supply; increase air supply size Clear ⁽¹⁾ Clear ⁽¹⁾

(1) Follow the **Pressure Relief Procedure** and disconnect the fluid line. If the pump starts when the air is turned on again, the line, etc. is clogged.

Parts List & Diagram

Tiger® 500 5:1 Pump

Model 1130-001

ITEM	PART #	DESCRIPTION	QTY	IN KIT
1	805784	Lock Washer	4	
2	806962	1" Steel Ball	2	
3	807511	Fluid Piston Spring	1	**
4	827427	Ball Retainer (prior to 6/03)	1	
	829769	Ball Retainer (after 6/03)	1	
5	814247	Air Valve Nut	3	
6	826060	Foot Valve	1	
7	828361	Pump Tube	1	
8	826097	Rod Seal, Buna-N	1	**
9	826201	Air Motor Cap	1	
10	826202	Pump Body	1	
11	826203	5/16 Star Washer	4	
12	826204	Upper Spring	1	*
13	826205	Lower Spring	1	*
14	826206	O-Ring	1	*
15	826207	O-Ring	1	*
16	828367	Adapter	1	
17	826209	Floating Seal Nut	1	
18	827893	Seal Housing	1	**
19	826211	O-Ring	1	*
20	826212	Upper Air Piston	1	
21	826213	Air Piston Adapter	1	
22	826242	Upper Toggle Plate	1	*
23	826215	Lower Toggle Plate	1	
24	826216	Air Motor Spacer	3	*
25	826217	Trip Plate	1	
26	826218	O-Ring	3	*
27	827807	Lower Spring, Outer	1	*
28	826220	Spring Retainer	1	
29	826221	Body Screw	4	
30	826223	Air Valve Screw	3	
31	826224	Washer	3	*
32	826227	Muffler Screen	1	
33	826228	Muffler Screen	1	**
34	826245	Rod	1	
35	826248	Wear Ring	1	**
36	830306	O-Ring	1	**
37	826253	Lower Air Piston	1	
38	831489	Grounding Lug (not shown)	1	
39	826665	Air Motor Screw	1	
40	826666	Adapter Screw	4	
41	826678	O-Ring	1	**
42	826678	O-Ring	1	**
43	827056	Fluid Piston	1	
44	827058	Fluid Piston Nut	1	
45	807060	O-Ring	1	**
46	827062	O-Ring	1	**
47	827064	Quad Ring (prior to 10/03)	1	**
	831638	O-Ring (after 10/03)	1	**

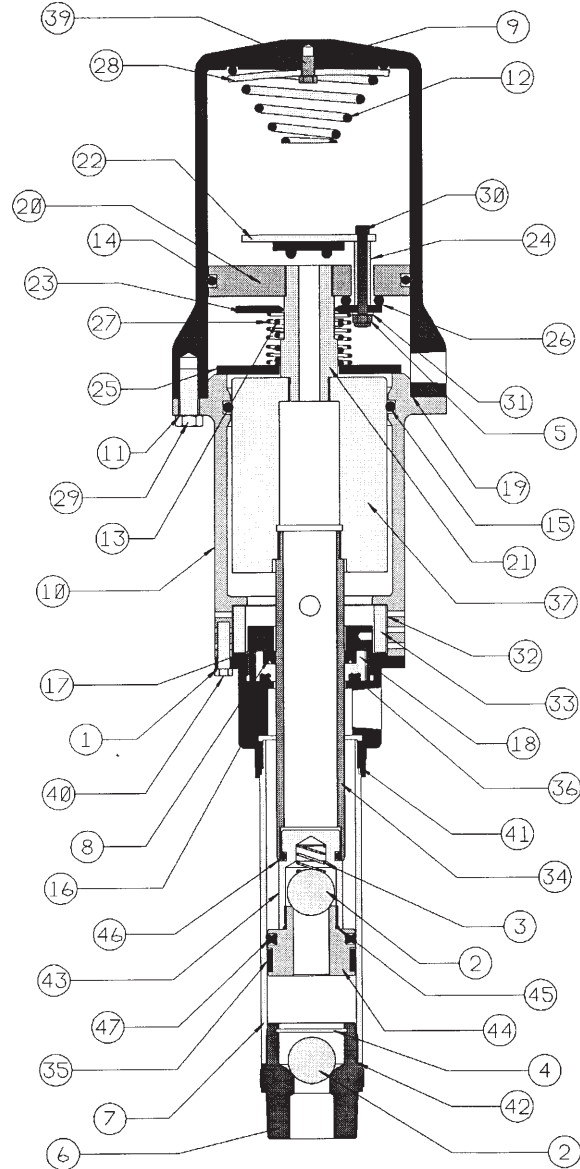

* INCLUDED IN REPAIR KIT 826280

** INCLUDED IN REPAIR KIT 826290

ACCESSORIES

Hose and Tube Kit 4410-017

- 3/8" x 3' air hose
- 3/4" x 5' fluid hose
- 3/8" air coupler
- 3/8" NPT(M) nipple
- 1" Telescoping Suction Tube
- Bung Adapter

Foot Mount Adapter 4411-018

Universal Bung Adapter 4411-009

Wall Mount Kit 4410-018

- 3/8" x 3' air hose
- 3/4" x 5' fluid hose
- 3/8" air coupler
- 3/8" NPT(M) nipple
- Wall Mount Bracket
- 1" x 6' suction hose
- 1" x 5' suction tube
- Bung Adapter
- 1" bung bushing
- 90° elbow

Quality Checklist

- Bill of Material checked for current content.
- Pump was tested in grease and met Balcrank® performance standards.

Revision Log:

Rev. H - Added grounding lug (item 48)
Rev. I - Added ball retainer 829769 (item 4)
Rev. J - Added O-Ring (item 47).

I _____
certify that this product meets or exceeds Balcrank's
high quality standards.

WARRANTY

All Balcrank® equipment sold by authorized Balcrank® distributors is warranted to their original customer to be free from defects in materials and workmanship for a period of one year from the date the equipment was sold to the original customer. Select equipment carries extended warranty terms as individually noted within the Balcrank® Lubrication Equipment & Accessories User Price List. Any Balcrank® equipment carrying an extended warranty will be warranted for the period indicated; those items carrying a "lifetime" warranty are warranted for a period of thirty years. All Balcrank® equipment determined by Balcrank® to have defective materials or workmanship within the one year warranty period will be repaired or replaced. For equipment carrying extended warranties Balcrank® will repair or replace the product including parts and labor for the first full year and will provide parts only for the remaining period of the specified warranty.

This warranty only covers equipment installed and operated according to applicable Balcrank® Service Bulletins and Installation Instructions. Any equipment claimed to be defective must be returned, freight prepaid, to an Authorized Balcrank® Service Center. If the part(s) or equipment is found to be defective, it will be repaired or replaced, and returned freight prepaid from the Authorized Service Center. If the claimed part(s) or equipment is found not to be defective, the Authorized Balcrank® Service Center will, upon written authorization being received from the original customer, repair them for a reasonable charge to the customer which will include all applicable parts, labor, and return transportation costs. Any equipment returned to Balcrank® must have the Warranty Service Claim number (WSC#) clearly marked on the outside of the carton. Balcrank's sole responsibility is for defects in material and workmanship, and Buyer's sole and exclusive remedy hereunder, shall be limited to repair or replacement of the defective part or equipment.

This warranty does not cover, nor shall Balcrank® be liable for repair or replacement of parts or equipment resulting from general wear and tear through use, or damage or failure caused by improper installation, abuse, misapplication, abrasion, corrosion, insufficient or improper maintenance, negligence, accident, alteration, or substitution of non-Balcrank component parts. Furthermore the Balcrank® Warranty for Lubrication Equipment and Accessories does not cover the following specific conditions:

- Failure or damage to equipment that is caused by dirt or debris in air and fluid lines. This includes, but is not limited to clogged inlet filters, strainers, or regulators; fluid meters; control handles; fluid tips; and valves.
- Failure of normal wear parts including but not limited to: "o"-rings, packings, seals and valves unless originally improperly installed by the factory.
- Products placed in applications for which their use was not intended. Examples include but are not limited to: A lubricant pump being used to pump solvents, or placing a piece of equipment intended strictly for indoor use in an outdoor application.
- Damage to equipment resulting from operation above and beyond Balcrank's recommendations.
- Leaks at air and fluid fittings and connections.
- Damage caused by thermal expansion when adequate pressure relief was not included in the system.
- Loose suction tubes on pumps.
- Reel spring tension adjustment.

THERE ARE NO OTHER WARRANTIES, EXPRESSED OR IMPLIED, INCLUDING WARRANTIES OF MERCHANTABILITY OR FITNESS FOR A PARTICULAR PURPOSE. IN NO EVENT SHALL BALCRANK BE LIABLE FOR ANY SPECIAL, CONSEQUENTIAL, OR OTHER DAMAGES OF SIMILAR NATURE, INCLUDING BUT NOT LIMITED TO LOST PROFITS, LOST PRODUCTION, PROPERTY DAMAGE, PERSONAL INJURY, WHETHER SUFFERED BY BUYER OR ANY THIRD PARTY, IRRESPECTIVE OF WHETHER CLAIMS OR ACTIONS, LEGAL OR EQUITABLE, FOR SUCH DAMAGES ARE BASED UPON CONTRACTS, WARRANTY, NEGLIGENCE, STRICT LIABILITY, OR OTHERWISE. ANY CLAIM OR ACTION FOR BREACH OF WARRANTY MUST BE BROUGHT WITHIN TWO (2) YEARS FROM THE DATE OF SALE TO THE ORIGINAL CUSTOMER.

PRODUCT EXTENDED WARRANTY

Tiger® 500 pumps are warranted to be free from defects in material and workmanship for a period of Thirty Years from the date installed in service by the original purchaser.

Balcrank® Products Inc.
115 Reems Creek Road
Weaverville, NC 28787
800-747-5300
800-763-0840 Fax
www.balcrank.com

Distributed by:

SERVICE BULLETIN SB1029
Rev. J 10/03
828065